

Instructions

Multispectrum IR Flame Detector
Model X3301



Table of Contents

DESCRIPTION	1	FEATURES	16
Outputs	1	SPECIFICATIONS	17
LED	2	REPLACEMENT PARTS	19
Oj (Optical Integrity)	2	Replacement Parts List.	19
Communication	3	DEVICE REPAIR AND RETURN	19
Data Logging	3	ORDERING INFORMATION	19
Integral Wiring Compartment	3	Accessories.	19
Detector Sensitivity Levels	3	X3301 Model Matrix	20
GENERAL APPLICATION INFORMATION	4	HIGH RESOLUTION FIELD OF VIEW DIAGRAMS	21
Response Characteristics.	4	APPENDIX A – FM APPROVAL AND PERFORMANCE REPORT	25
Important Application Considerations	4	APPENDIX B – CSA APPROVAL	33
IMPORTANT SAFETY NOTES	4	APPENDIX C – ATEX APPROVAL	34
INSTALLATION	5	APPENDIX D – IECEx APPROVAL	36
Detector Positioning	5	APPENDIX E – EN54 APPROVALS	37
Detector Orientation	6	APPENDIX F – OFFSHORE APPROVALS	38
Protection Against Moisture Damage.	6	APPENDIX G – ADDITIONAL APPROVALS	39
Wiring Procedure	6	APPENDIX H – DECLARATION OF CONFORMITY	40
Setting Device Network Addresses (EQP Model Only)	13		
STARTUP PROCEDURE	14		
Fire Alarm Test	14		
TROUBLESHOOTING	14		
MAINTENANCE	15		
Cleaning Procedure	15		
Oj Reflector Plate Removal and Replacement	15		
Periodic Checkout Procedure	16		
Clock Battery	16		

Multispectrum IR Flame Detector X3301

IMPORTANT

Be sure to read and understand the entire instruction manual before installing or operating the flame detection system. Any deviation from the recommendations in this manual may impair system performance and compromise safety.

ATTENTION

*The X3301 includes the Automatic **oi**® (Optical Integrity) feature — a calibrated performance test that is automatically performed once per minute to verify complete detector operation capabilities. **Testing with an external test lamp is not approved or required.***

DESCRIPTION

The X3301 is a multispectrum infrared (IR) flame detector. It provides unsurpassed detection of fires from light to heavy hydrocarbon fuels combined with the highest degree of false alarm rejection. The detector has Division and Zone explosion-proof ratings and is suitable for use in indoor and outdoor applications.

The X3301 contains three IR sensors with their associated signal processing circuitry. The standard output configuration includes fire, fault and auxiliary relays. Output options include:

- 0–20 mA output (in addition to the three relays)
- Pulse output for compatibility with existing Detector Electronics Corporation (Det-Tronics) controller based systems (with fire and fault relays)
- Eagle Quantum Premier® (EQP) compatible model (no analog or relay outputs)
- HART communication



A tri-color LED on the detector faceplate indicates normal condition and notifies personnel of fire alarm or fault conditions.

Microprocessor controlled heated optics increase resistance to moisture and ice.

The X3301 housing is available in copper-free aluminum or stainless steel, with Type 4X and IP66/IP67 rating.

OUTPUTS

Relays

The standard detector is furnished with fire, fault, and auxiliary relays. All three relays are rated 5 amperes at 30 Vdc.

The Fire Alarm relay has redundant terminals and normally open / normally closed contacts, normally de-energized operation, and latching or non-latching operation.

The Fault relay has redundant terminals and normally open contacts, normally energized operation, and latching or non-latching operation.

The Auxiliary relay has normally open / normally closed contacts, and is configurable for energized or de-energized operation, and latching or non-latching operation to perform as a secondary relay for fire alarm or fault. All relay functions can be configured by using the latest version of Inspector Monitor.

0 to 20 mA Output

A 0–20 mA output is available as an option (in addition to the three relays). This option provides a 0–20 mA dc current output for transmitting detector status information to other devices. The circuit can be wired in either an isolated or non-isolated configuration and can drive a maximum loop resistance of 500 ohms from 18 to 19.9 Vdc and 600 ohms from 20 to 30 Vdc. Table 1 indicates the detector status conditions represented by the various current levels. The output is calibrated at the factory, with no need for field calibration. A model with relays and 0–20 mA with HART is also available. Refer to Addendum number 95-8577 for complete details.

NOTE

The output of the 0–20 mA current loop is not monitored by the fault detection circuitry of the X3301. Therefore, an open circuit on the loop will not cause the fault relay to change state or the detector status LED to indicate a fault. The status of the LED always follows the status of the relays.

An alarm condition will normally over-ride a fault condition, unless the nature of the fault condition impairs the ability of the detector to generate or maintain an alarm output, i.e., loss of operating power.

Table 1—Detector Status Conditions Indicated by Current Level

Current Level (± 0.3 mA)	Detector Status
0 mA	Power Fault
1 mA	General Fault
2 mA	o_i Fault
3 mA	High Background IR Fault
4 mA	Normal Operation
20 mA	Fire Alarm

LON/SLC Output

The EQP model is designed for use exclusively with the Det-Tronics Eagle Quantum Premier system. The detector communicates with the system controller over a digital communication network or LON/SLC (Local Operating Network / Signaling Line Circuit). The LON/SLC is a fault tolerant, two wire digital communication network arranged in a loop configuration. Analog and relay outputs are not available on this model.

LED

A tri-color LED on the detector faceplate indicates normal condition and notifies personnel of fire alarm or fault conditions. Table 2 indicates the condition of the LED for each status.

Table 2—Detector Status Indicator

Detector Status	LED Indicator
Power On/Normal Operation (no fault or fire alarm)	Green
Fault	Yellow
Fire (Alarm)	Red
Low Sensitivity	One Yellow Flash During Power-up
T-Low Sensitivity	Three Yellow Flashes During Power-up
Medium Sensitivity	Two Yellow Flashes During Power-up
Very High Sensitivity	Four Yellow Flashes During Power-up

NOTE: See "Detector Sensitivity Levels" for additional information.

o_i (OPTICAL INTEGRITY)

Automatic o_i

The X3301 includes the Automatic **o_i** feature — a calibrated performance test that is automatically performed once per minute to verify complete detector operation capabilities. No testing with an external test lamp is required. The detector automatically performs the same test that a maintenance person with a test lamp would perform — once every minute, 60 times per hour. However, a successful Automatic **o_i** test does not produce an alarm condition.

The detector signals a fault condition when less than half of the detection range remains. This is indicated by the Fault output and is evident by the yellow color of the LED on the face of the detector. The **o_i** fault condition is self-clearing if the optical contamination is temporary. If the contamination is not automatically cleared and the **o_i** fault remains, the detector may require cleaning or service. See the "Troubleshooting" section for further information.

Magnetic o_i / Manual o_i

The detector also incorporates both Magnetic **o_i** (Mag **o_i**) and Manual **o_i** (Man **o_i**) features that provide the same calibrated test as the Automatic **o_i**, and in addition actuates the Alarm output to verify operation for preventive maintenance requirements. These features can be performed at any time and eliminate the need for testing with a non-calibrated external test lamp.

 **CAUTION**

These tests require disabling of all extinguishing devices to avoid release resulting from a successful test.

The Mag **oj** test is performed by placing a magnet at the location marked "MAG **oj**" on the outside of the detector (see Figure 2). The Man **oj** test is accomplished by connecting the **oj** lead (terminal 22) to power supply minus via an external switch. The magnet or switch must be held in place for a minimum of six seconds to complete the test. Either of these test methods activates the calibrated IR emitters. If the resulting signal meets the test criteria, indicating that greater than half of the detection range remains, the fire alarm output of the detector is activated. On all models other than the EQP, this condition remains until the magnet is removed or the switch is released, regardless of whether the detector has been configured for latching or non-latching operation. On model EQP, the condition remains for four seconds.

If less than half of the detection range remains, no alarm is produced and a fault is generated. The fault indication can be reset by momentarily applying the Mag **oj** or Man **oj** switch. In this case, the detector's optics should be cleaned and the **oj** tests should be repeated. See the "Cleaning Procedure" section of this manual for details.

NOTE

*Refer to Appendix A for FM verification of the **oj** function.*

COMMUNICATION

The X3301 is furnished with an RS-485 interface for communicating status and other information with external devices. The RS-485 supports Modbus protocol, with the detector configured as a slave device.

For HART communication, connect a HART communicator across a 250 ohm resistor in the 0-20 mA loop.

NOTE

The EQP model uses LON/SLC communication. RS-485 and HART communication are not available on the EQP model.

NOTE

RS-485 communication is not available on HART equipped models.

DATA LOGGING

Data logging capability is also provided. Status conditions such as normal, power down, general and **oj** faults, fire alarm, time and temperature are recorded. Each event is time and date stamped, along with the temperature and input voltage. Event data is stored in non-volatile memory when the event becomes active, and again when the status changes. Data is accessible using Det-Tronics' Inspector Connector accessory, RS-485, or the EQP Controller.

INTEGRAL WIRING COMPARTMENT

All external wiring to the device is connected within the integral junction box. The detector is furnished with four conduit entries, with either 3/4 inch NPT or M25 threads.

DETECTOR SENSITIVITY LEVELS

There are four factory configured sensitivity levels available for the X3301 Flame Detector:

Very High, Medium, Low, and T-Low.

The following criteria should be considered when choosing a sensitivity level for the intended application:

- Detector placement
- Speed of response based on fuel type and fire size (see Appendix A for examples of response times)
- Distance between the hazard and the flame detector

Additional information on X3301 Flame Detector performance results and sensitivities can be found in Appendix A, the FM Approval, and Performance Report.

Consult the factory with any questions on how to choose the optimum sensitivity level for the intended application.

GENERAL APPLICATION INFORMATION

RESPONSE CHARACTERISTICS

Response is dependent on the detector's sensitivity setting, distance, type of fuel, temperature of the fuel, and time required for the fire to come to equilibrium. As with all fire tests, results must be interpreted according to an individual application.

See Appendix A for third-party approved fire test results. Additional fire test results are available from Det-Tronics.

IMPORTANT APPLICATION CONSIDERATIONS

In applying any type of sensing device as a fire detector, it is important to know of any conditions that can prevent the device from responding to fire, and also to know what other sources besides fire can cause the device to respond.

Welding

It is recommended that the system be bypassed during welding operations in situations where the possibility of a false alarm cannot be tolerated. Gas welding mandates system bypass, since the gas torch is an actual fire. Arc welding rods can contain organic binder materials in the flux that burn during the welding operation and are detectable by the X3301. Welding rods with clay binders do not burn and will not be detected by the X3301. However, system bypass is always recommended, since the material being welded may be contaminated with organic substances (paint, oil, etc.) that will burn and possibly cause the X3301 to alarm.

Due to the possibility of an alarm condition, arc welding should not be performed within 40 feet (12.2 m) of the detector configured to very high sensitivity, within 10 feet (3.0 m) at medium sensitivity, within 5 feet (1.5 m) at T-Low sensitivity, or at Low sensitivity.

Artificial Lighting

The X3301 should not be located within 3 feet (0.9 m) of artificial lights. Excess heating of the detector could occur due to heat radiating from the lights.

EMI/RFI Interference

The X3301 is resistant to interference by EMI and RFI, and is EMC Directive compliant. It will not respond to a 5 watt walkie-talkie at distances greater than 1 foot (0.3 m). Do not operate a walkie-talkie within 1 foot (0.3 m) of the X3301.

Background IR Sources

IR energy is emitted from fire as well as non-fire sources. Because non-fire sources may in some cases emit IR energy in wavelengths that are monitored by the detector, special detector installation and configuration considerations need to be given in these situations.

The detector differentiates fire from non-fire sources by using optical filters and algorithms that analyze the characteristics of the IR energy that is within its field of view (FOV). Typically, non-fire IR sources do not qualify these algorithms. However, if an object or person moves between the non-fire IR source and the detector the randomly modulated IR energy that is produced could mimic a fire signal.

In order to optimize the detector's false alarm rejection performance, it is preferred that the detectors FOV be controlled to the area that requires flame detection monitoring. Whenever possible, sources of intense IR emissions should be eliminated from the detector's FOV. Although elimination of all background IR sources may not be possible, controlling the detectors FOV through careful installation and aiming will help to optimize the detector's performance.

It is recommended that a flame detector that has an intense IR source within its FOV (e.g., turbine enclosure, fin-fan cooler) be inhibited prior to personnel working on or in close proximity to the detector. Consult the factory for software and hardware configurations that can help mitigate the effects of background IR sources.

Non-Carbon Fires

The X3301 is a multiple spectrum IR device with detection limited to carbonaceous fuels. It should not be used to detect fires from fuels that do not contain carbon, such as hydrogen, sulfur, and burning metals.

IMPORTANT SAFETY NOTES



Do not open the detector assembly in a hazardous area when power is applied. The detector contains limited serviceable components and should never be opened. Doing so could disturb critical optical alignment and calibration parameters, possibly causing serious damage.

CAUTION

The wiring procedures in this manual are intended to ensure proper functioning of the device under normal conditions. However, because of the many variations in wiring codes and regulations, total compliance to these ordinances cannot be guaranteed. Be certain that all wiring complies with the NEC as well as all local ordinances. If in doubt, consult the authority having jurisdiction before wiring the system. Installation must be done by a properly trained person.

CAUTION

To prevent unwanted actuation or alarm, extinguishing devices must be disabled prior to performing system tests or maintenance.

CAUTION

The multispectrum IR flame detectors are to be installed in places where the risk of mechanical damage is low.

ATTENTION

Remove the protective cover from the front of the detector before activating the system.

ATTENTION

Observe precautions for handling electrostatic sensitive devices.

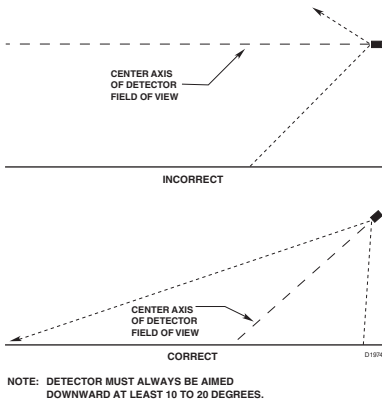

Figure 1—Detector Orientation Relative to Horizon

INSTALLATION

NOTE

The recommended lubricant for threads and O-rings is a silicone-free grease (p/n 005003-001) available from Det-Tronics. Under no circumstances should a lubricant containing silicone be used.

DETECTOR POSITIONING

Detectors should be positioned to provide the best unobstructed view of the area to be protected. The following factors should also be taken into consideration:

- Identify all high risk fire ignition sources.
- Be sure that enough detectors are used to adequately cover the hazardous area.
- Be sure that the unit is easily accessible for cleaning and other periodic servicing.
- Verify that all detectors in the system are properly located and positioned so that any fire hazards are within both the Field of View (FOV) and detection range of the detector. The Q1201C Laser Aimer is recommended for establishing the detector's FOV. Refer to the "High Resolution Field of View Diagrams" section for specific information regarding detector range and FOV.
- The detector should be aimed downward at least 10–20 degrees to allow lens openings to drain. See Figure 1. **The detector should be positioned so that its FOV does not cover areas outside the area that requires flame detection monitoring.** This will minimize the possibility of false alarms caused by activities outside the area requiring protection.
- The detector must be mounted on a rigid surface in a low vibration area.
- Dense fog, rain, or ice can absorb IR radiation and reduce the sensitivity of the detector. To ensure optimum performance, be certain that the internal optical heater is enabled on detectors that are used in applications where snow, ice, and condensation are likely to occur.

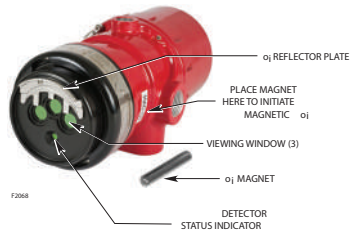

Figure 2—Front View of the X3301

- Although IR detectors are less affected by smoke than other detectors, the X3301 should not be placed where rising combustion products can obscure its vision. If smoke is expected before fire, smoke or other alternative detectors should be used in conjunction with the X3301. For indoor applications, if dense smoke is expected to accumulate at the onset of a fire, install the detector on a side wall at least a few feet (approximately 1 meter) down from the ceiling.
- If possible, fire tests can be conducted to verify correct detector positioning and coverage.
- For ATEX/IECEx installations, the X3301 Flame Detector housing must be electrically connected to earth ground.

DETECTOR ORIENTATION

Refer to Figure 2 and ensure that the **oi** reflector plate will be oriented as shown when the X3301 is installed and sighted. This will ensure proper operation of the **oi** system and will also minimize the accumulation of moisture and contaminants between the **oi** reflector plate and the viewing windows.

IMPORTANT

*If removed, the **oi** reflector plate must be securely tightened to ensure proper operation of the **oi** system (40 oz./inches [28.2 N·cm] recommended).*

PROTECTION AGAINST MOISTURE DAMAGE

It is important to take proper precautions during installation to ensure that moisture will not come in contact with the electrical connections or components of the system. The integrity of the system regarding moisture protection must be maintained for proper operation and is the responsibility of the installer. Verify that all covers are securely tightened upon installation.

If conduit is used, we recommend installing drains, according to local codes, at water collection points to automatically drain accumulated moisture. It is also recommended to install at least one breather,

according to local codes, at upper locations to provide ventilation and allow water vapor to escape.

Conduit raceways should be inclined so that water will flow to low points for drainage and will not collect inside enclosures or on conduit seals. If this is not possible, install conduit drains above the seals to prevent the collection of water or install a drain loop below the detector with a conduit drain at the lowest point of the loop.

Conduit seals are not required for compliance with explosion-proof installation requirements, but are highly recommended to prevent water ingress in outdoor applications. Units with M25 threads must use an IP66 washer to prevent water ingress.

WIRING PROCEDURE

Wire Size and Type

The system should be wired according to local codes. The wire size selected should be based on the number of detectors connected, the supply voltage and the cable length. Typically 16 AWG, 2.5 mm² shielded cable is recommended. Wires should be stripped 3/8 inch (9 mm). A minimum input voltage of 18 Vdc must be present at the X3301.

NOTE

Refer to “Power Consumption” in the “Specifications” section of this manual.

The use of shielded cable is required to protect against interference caused by EMI and RFI. When using cables with shields, terminate the shields as shown in Figures 8 through 13 and Figure 16. Consult the factory if not using shielded cable.

In applications where the wiring cable is installed in conduit, the conduit must not be used for wiring to other electrical equipment.

If disconnection of power is required, separate disconnect capability must be provided.

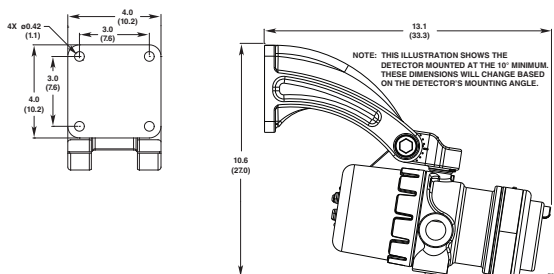

Figure 3—Q9033 Mounting Arm without Collar Attachment Dimensions in Inches (cm)
(See Figure 1 for Correct Detector Orientation.)

 **WARNING**

All entries must contain appropriately rated plugs or fittings. It is required that each plug or fitting be wrench-tightened to an appropriate installation torque and meet the minimum thread engagement requirements per the applicable local standards, codes, and practices in order to retain the defined ratings. PTFE sealant or equivalent should be used on NPT threads.

IMPORTANT

Devices certified for hazardous locations shall be installed in accordance with EN/IEC 60079-14 and NEC 505.

 **CAUTION**

Installation of the detector and wiring should be performed only by qualified personnel.

Detector Installation

Install the mounting arm assembly on a rigid surface. The ideal installation surface should be free of vibration and suitable to receive 3/8 inch or M10 bolts with a length of at least 1 inch (25 mm). The surface must also have sufficient capacity to hold the detector and mounting arm weights (see "Specifications" section). Refer to the Q9033 Mounting Arm and Collar Attachment manual, number 95-8686, for additional installation information. See Figure 3 for dimensions.

Relay and 0-20 mA Output Models

Follow the instructions below to install the X3301.

1. Make field connections following local ordinances and guidelines in this manual.
 - Figure 4 shows the wiring terminal strip located inside the detector's integral junction box.
 - Figure 5 shows the wiring terminal identification for the X3301 Flame Detector.
 - Figure 6 shows a resistor installed within the integral wiring compartment of the detector (refer to "EOL, Fire and Fault Resistors" for details).

- Figures 7, 8 and 9 provide examples of typical installations with a X3301 wired to a fire alarm panel.
- If the detector is equipped with a 0-20 mA output, refer to Figures 10 through 13.

2. Check all field wiring to be sure that the proper connections have been made.

IMPORTANT

Do not test any wiring connected to the detector with a meg-ohmmeter. Disconnect wiring at the detector before checking system wiring for continuity.

3. Make the final sighting adjustments and use a 14 mm hex wrench to ensure that the mounting arm assembly is tight.

EOL, Fire and Fault Resistors (Not Used with EQP Model)

To ensure that the insulating material of the wiring terminal block will not be affected by the heat generated by resistors, observe the following guidelines when installing the resistors.

1. Resistors must be rated appropriately for the application and have a maximum power dissipation of 5 watts.

NOTE

This applies to ATEX/IECEx installations only.

2. Resistor leads should be cut to a length of approximately 1 1/2 inches (40 mm).
3. Bend the leads and install the resistors as shown in Figure 6.
4. Maintain a 3/8 inch (10 mm) minimum gap between the resistor body and the terminal block or any other neighboring parts.

NOTE

The resistors can only be used within the flameproof(Ex d) terminal compartment. Unused conduit entries shall be closed with suitable blanking elements.



Figure 4—X3301 Terminal Block

9	mA +	19	mA -	29	SPARE
8	mA + REF	18	mA - REF	28	SPARE
7	COM FIRE	17	COM FIRE	27	COM AUX
6	NO FIRE	16	NO FIRE	26	NO AUX
5	NC FIRE	15	NC FIRE	25	NC AUX
4	COM FAULT	14	COM FAULT	24	RS485 A
3	NO FAULT	13	NO FAULT	23	RS485 B
2	+Vin	12	+Vin	22	MAN O ₁
1	-Vin	11	-Vin	21	-Vin

E2061

Figure 5—X3301 Wiring Terminal Identification

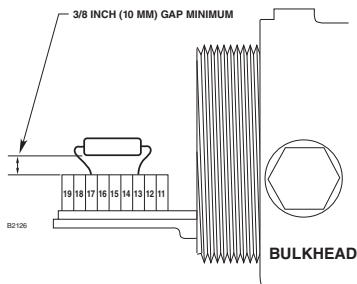
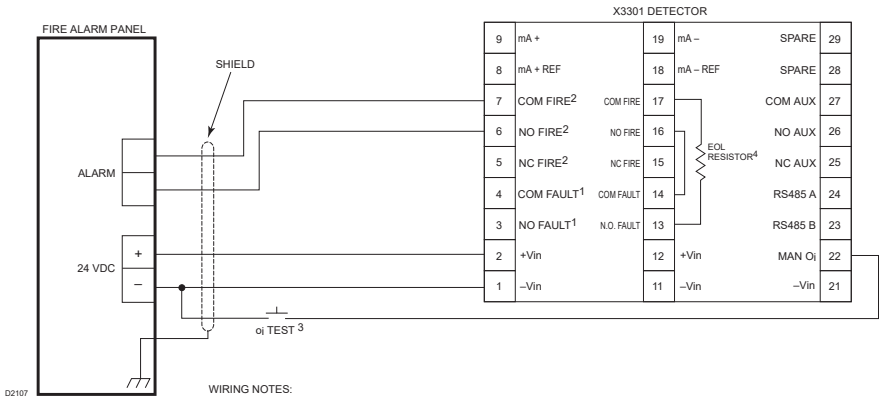
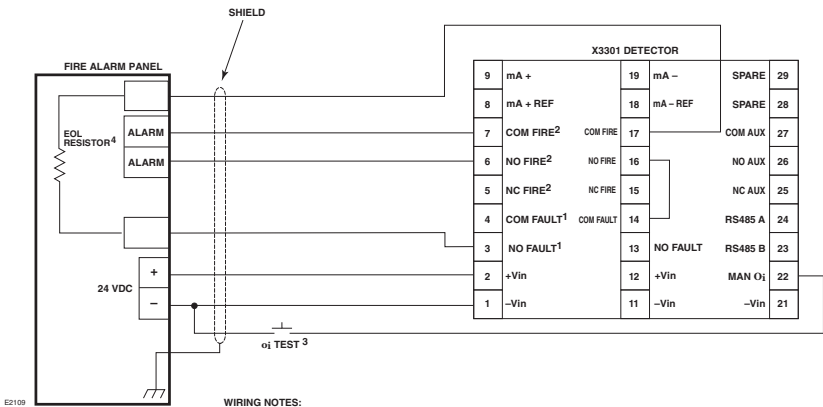

Figure 6—Resistor Installation (For Ex d Wiring only)



- 1 IN NORMAL OPERATION WITH NO FAULTS OCCURRING, THE FAULT RELAY COIL IS ENERGIZED AND THE NORMALLY OPEN (NO) AND COMMON (COM) CONTACTS ARE CLOSED.
- 2 ALARM RELAY IS NORMALLY DE-ENERGIZED WITH NO ALARM CONDITION PRESENT.
- 3 INDIVIDUAL MANUAL α TEST SWITCHES CAN BE INSTALLED REMOTELY OR A DETECTOR SELECTOR AND ACTIVATION SWITCH CAN BE INSTALLED AT THE FIRE PANEL. TEST SWITCHES ARE NOT SUPPLIED.
- 4 REFER TO SPECIFICATIONS SECTION FOR EOL RESISTOR VALUES. REFER TO EOL RESISTORS SECTION FOR INSTALLATION DETAILS.
- 5 PROPERLY CERTIFIED HAZARDOUS LOCATION METALLIC CABLE GLANDS OR STOP PLUGS ARE REQUIRED TO FILL ALL CONDUIT ENTRIES.
- 6 SHIELD MUST BE CONNECTED TO THE METALLIC CABLE GLAND. MAKE CERTAIN THAT THE INSULATION IS REMOVED TO ENSURE ELECTRICAL CONNECTION BETWEEN THE SHIELD AND THE HOUSING.

Figure 7—Ex d Wiring Option



- 1 IN NORMAL OPERATION WITH NO FAULTS OCCURRING, THE FAULT RELAY COIL IS ENERGIZED AND THE NORMALLY OPEN (NO) AND COMMON (COM) CONTACTS ARE CLOSED.
- 2 ALARM RELAY IS NORMALLY DE-ENERGIZED WITH NO ALARM CONDITION PRESENT.
- 3 INDIVIDUAL MANUAL α TEST SWITCHES CAN BE INSTALLED REMOTELY OR A DETECTOR SELECTOR AND ACTIVATION SWITCH CAN BE INSTALLED AT THE FIRE PANEL. TEST SWITCHES ARE NOT SUPPLIED.
- 4 EOL RESISTOR SUPPLIED BY PANEL.
- 5 PROPERLY CERTIFIED HAZARDOUS LOCATION METALLIC CABLE GLANDS OR STOP PLUGS ARE REQUIRED TO FILL ALL CONDUIT ENTRIES.
- 6 SHIELD MUST BE CONNECTED TO THE METALLIC CABLE GLAND. MAKE CERTAIN THAT THE INSULATION IS REMOVED TO ENSURE ELECTRICAL CONNECTION BETWEEN THE SHIELD AND THE HOUSING.

Figure 9—Ex d e Wiring Option

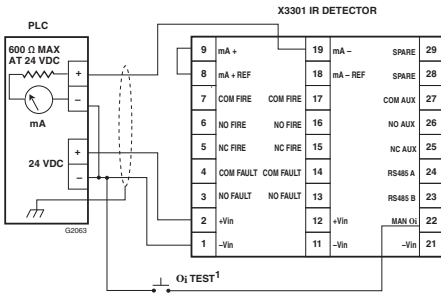

Figure 10—X3301 Detector Wired for Non-Isolated 0 to 20 mA Current Output (Sourcing)

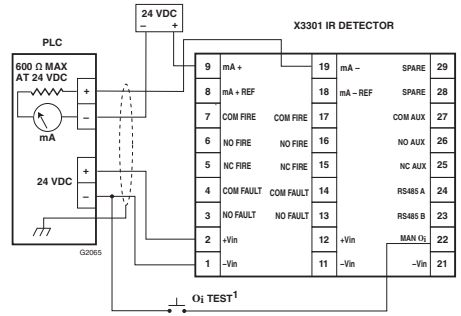

Figure 12—X3301 Detector Wired for Isolated 0 to 20 mA Current Output (Sourcing)

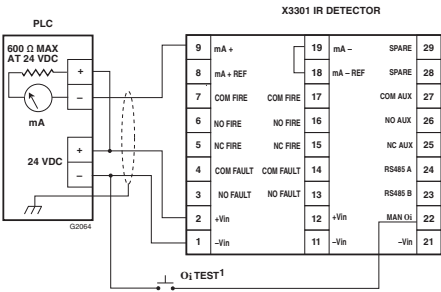

Figure 11—X3301 Detector Wired for Non-Isolated 0 to 20 mA Current Output (Sinking)

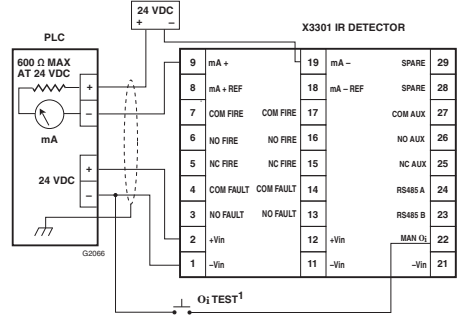

Figure 13—X3301 Detector Wired for Isolated 0 to 20 mA Current Output (Sinking)

NOTES: 1. **INDIVIDUAL MANUAL o_j TEST SWITCHES CAN BE INSTALLED REMOTELY OR A DETECTOR SELECTOR AND ACTIVATION SWITCH CAN BE INSTALLED AT THE FIRE PANEL. TEST SWITCHES ARE NOT SUPPLIED.**

EQP Model

1. Connect external wires to the appropriate terminals inside the device junction box, shown in Figure 14. See Figure 15 for terminal identification.
2. Connect the shield of the power cable to "earth ground" at the power source.
3. Connect shields for the LON cable as indicated. See Figure 16.

NOTE

DO NOT ground any shields at the detector housing.

4. With input power disconnected, set the device network address (see the "Setting Device Network Addresses" section of this manual for switch setting procedure).

5. Check all field wiring to be sure that the proper connections have been made.
6. Replace and securely tighten the device cover before applying input power.
7. Make the final sighting adjustments and use a 14 mm hex wrench to ensure that the mounting arm assembly is tight.

NOTE

Refer to the Eagle Quantum Premier system manual, number 95-8533, for information regarding power requirements, network communication cable requirements, and configuration.



Figure 14—X3301 Terminal Block (EQP Model)

6	SHIELD	16	SHIELD
5	COM 1 A	15	COM 2 A
4	COM 1 B	14	COM 2 B
3	PWR SHIELD	13	PWR SHIELD
2	+Vin	12	+Vin
1	-Vin	11	-Vin

C2089

Figure 15—Wiring Terminal Identification for X3301 EQP Model

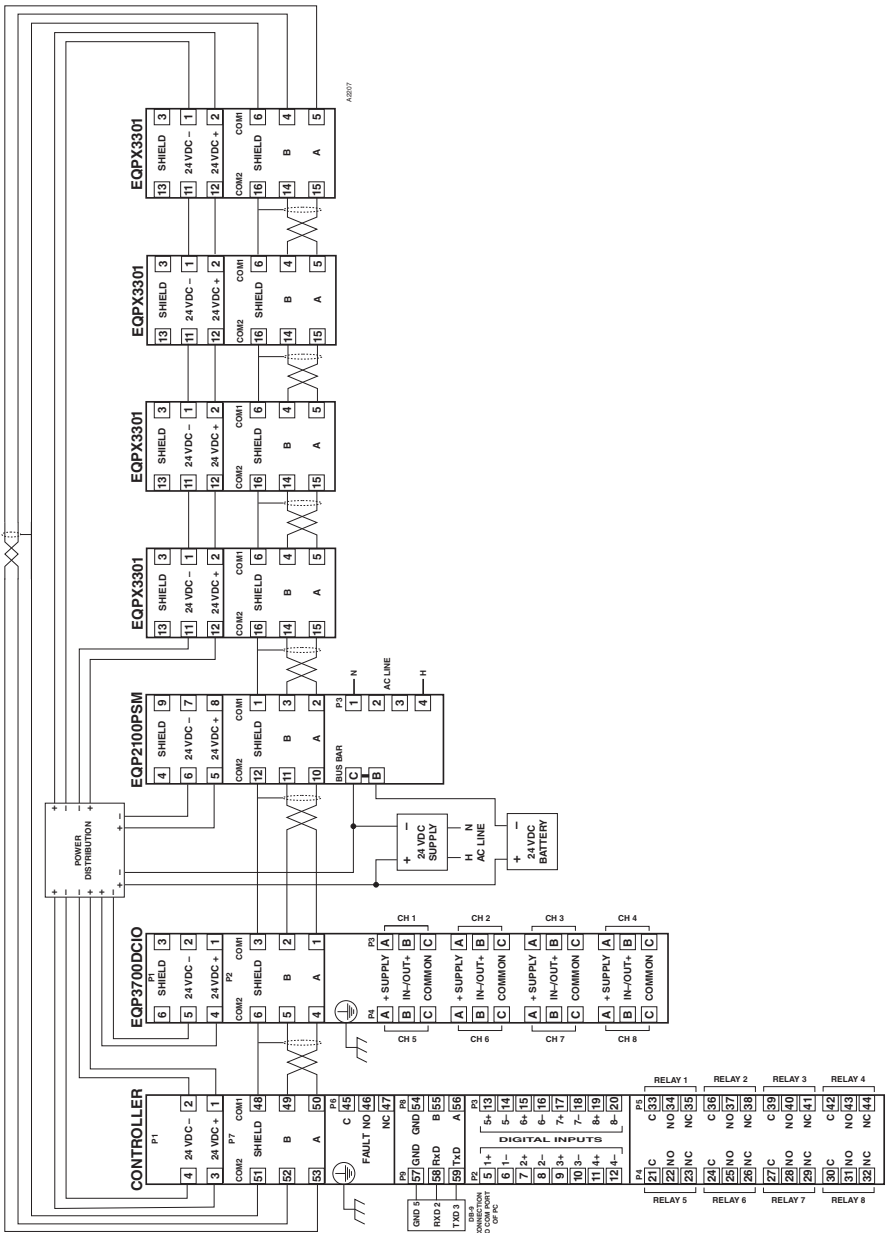

Figure 16—A Typical EQP System

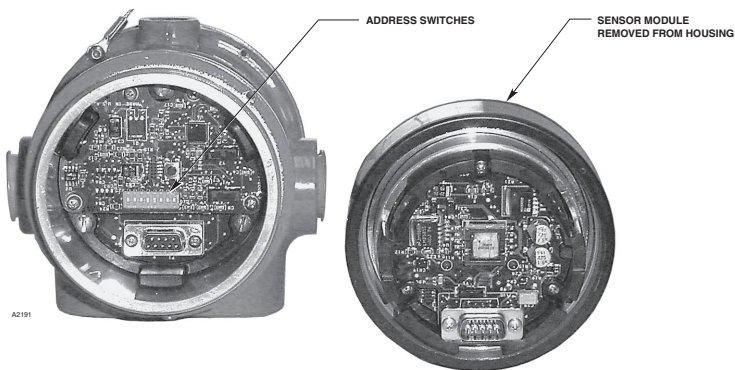

Figure 17—Location of Address Switches

SETTING DEVICE NETWORK ADDRESSES (EQP Model Only)

Overview of Network Addresses

Each device on the LON must be assigned a unique address. Addresses 1 to 4 are reserved for the controller. Valid addresses for field devices are from 5 to 250.

IMPORTANT

If the address is set to 0 or an address above 250, the switch setting will be ignored.

Duplicated addresses are not automatically detected. Modules given the same address will use the number given and report to the controller using that address. The status word will show the latest update, which could be from any of the reporting modules using that address.

Setting Field Device Addresses

Selection of the node address is done by setting rocker switches on an 8 switch "DIP Switch Assembly" within the detector's housing. Refer to Figure 16 for switch location.

WARNING

The network address switches are located within the detector housing. Disassembly of the detector head that contains powered electrical circuits is required to gain access to the network address switches. For hazardous areas, the area must be de-classified before attempting disassembly of the device. Always observe precautions for handling electrostatic sensitive devices.

The address number is binary encoded with each switch having a specific binary value with switch 1 being the LSB (Least Significant Bit), see Figure 17. The device's LON address is equal to the added value of all closed rocker switches. All "Open" switches are ignored.

Example: for node No. 5, close rocker switches 1 and 3 (binary values 1 + 4); for node No. 25, close rocker switches 1, 4 and 5 (binary values 1 + 8 + 16).

NOTE

*The field device sets the LON address only when power is applied to the device. Therefore, it is important to set the switches **before** applying power. If an address is ever changed, system power must be cycled before the new address will take effect.*

After setting address switches, record the address number and device type.

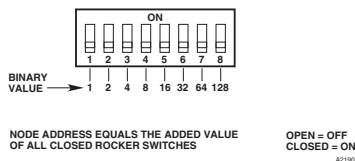

Figure 18—Address Switches for X3301 A2190

STARTUP PROCEDURE

When installation of the equipment is complete, perform the "Fire Alarm Test" below.

FIRE ALARM TEST

1. Disable any extinguishing equipment that is connected to the system.
2. Apply input power to the system.
3. Initiate an **oi** test (see "Magnetic **oi** / Manual **oi**" under "Optical Integrity" in the "Description" section of this manual).
4. Repeat this test for all detectors in the system. If a unit fails the test, refer to the "Troubleshooting" section of this manual.
5. Verify that all detectors in the system are properly aimed at the area to be protected. (The Q1201C Laser Aimer is recommended for this purpose.)
6. Enable extinguishing equipment when the test is complete.

TROUBLESHOOTING



WARNING

The sensor module ("front" half of the detector) contains no user serviceable components and should never be tampered with.

1. Disable any extinguishing equipment that is connected to the unit.
2. Inspect the viewing windows for contamination and clean as necessary. The detector is relatively insensitive to airborne contaminants, however, thick deposits of ice, dirt, or oil will reduce sensitivity. (Refer to the "Maintenance" section of this manual for complete information regarding cleaning of the detector viewing windows.)

3. Check input power to the unit.
4. If the fire system has a logging function, check the fire panel log for output status information. See Table 3 for information regarding 0–20 mA output.
5. The use of the Enhanced Flame Inspector cable and software from Det-Tronics can be considered to determine the nature of the fault condition. Refer to instruction manual 95-8751 for more information.
6. Turn off the input power to the detector and check all wiring for continuity. **Important: Disconnect wiring at the detector before checking system wiring for continuity.**
7. If all wiring checks out and cleaning of the **oi** plate/window did not correct the fault condition, check for high levels of background IR radiation by covering the detector with the factory supplied cover or aluminum foil. If the fault condition clears within six minutes or less, extreme background IR is present. Re-adjust the view of the detector away from the IR source or relocate the detector.
8. Remove factory supplied cover or aluminum foil from the detector and verify the detector has returned to normal operation before enabling any extinguishing equipment attached to the unit.

If none of these actions corrects the problem, please contact your local Det-Tronics Representative or alternatively you may contact Det-Tronics Technical Support by calling 1-800-765-3473 ext 2 (M-F, 8am to 5pm CST) to obtain assistance.

NOTE

It is highly recommended that a complete spare be kept on hand for field replacement to ensure continuous protection.

Table 3—Current Level Output Troubleshooting Guide

Current Level (±0.3 mA)	Status	Action
0 mA	Power Fault	Check system wiring
1 mA	General Fault	Cycle power ¹
2 mA	oi Fault	Clean windows ²
3 mA	High Background IR Fault	Remove IR source or aim detector away from IR source
4 mA	Normal Operation	
20 mA	Fire Alarm	

¹ If fault continues, return device to factory for repair.

² See "Maintenance" section for cleaning procedure.

NOTE: For additional troubleshooting guides, refer to the Enhanced Flame Inspector instruction manual (95-8751).

MAINTENANCE

IMPORTANT

Periodic flamepath inspections are not recommended, since the product is not intended to be serviced and provides proper ingress protection to eliminate potential deterioration of the flamepaths.



WARNING

To avoid a potential electrostatic discharge (ESD), the painted surface of the detector should only be cleaned with a damp cloth.



WARNING

The sensor module (“front” half of the detector) contains no user serviceable components and should never be tampered with.

NOTE

Refer to the X3301 Safety manual, number 95-8720, for specific requirements and recommendations applicable to the proper installation, operation, and maintenance of all SIL-Certified X3301 Flame Detectors.

To maintain maximum sensitivity and false alarm resistance, the viewing windows of the X3301 must be kept relatively clean. Refer to the following procedure for cleaning instructions.

CLEANING PROCEDURE



CAUTION

Disable any extinguishing equipment that is connected to the unit to prevent unwanted actuation.

To clean the windows and **o_i** reflector plate, use the window cleaner (p/n 001680-001) and a soft cloth, cotton swab, or tissue and refer to the following procedure:

1. Disable any extinguishing equipment that is connected to the unit.
2. Since the X3301 is less affected by contamination than other detectors, removal of the **o_i** reflector plate is needed only under extreme conditions. In addition, it is not necessary to achieve perfect cleanliness, because IR is not significantly absorbed by slight films of oil and/or salt. If a fault condition is still indicated after cleaning, remove and clean the **o_i** reflector plate using the **o_i** Reflector Plate Removal and Replacement procedure.

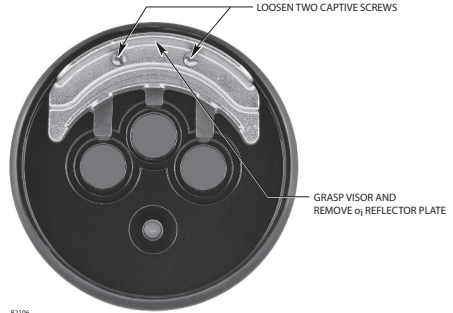

Figure 19—**o_i** Reflector Plate Removal

3. Clean all three viewing windows and reflector surfaces thoroughly. Use a cotton swab and the Det-Tronics window cleaning solution. Use Isopropyl alcohol for contaminations that the Det-Tronics window cleaning solution cannot remove.

IMPORTANT

When used in extreme environments, the reflective surface of the detector **o_i** reflector plate may eventually deteriorate, resulting in reoccurring **o_i** faults and the need for **o_i** reflector plate replacement.

o_i REFLECTOR PLATE REMOVAL AND REPLACEMENT

1. Disable any extinguishing equipment that is connected to the unit.
2. Loosen the two captive screws, then grasp the **o_i** reflector plate by the visor and remove it from the detector. See Figure 19.
3. Install the new (or cleaned) **o_i** reflector plate.

NOTE

When installing the stainless steel **o_i** reflector plate, ensure that the gasket is present and correctly seated to prevent moisture or contaminants from penetrating behind the plate. To ensure even seating, tighten both screws equally.

4. Recalibrate the detector's **o_i** system. Refer to the Enhanced Flame Inspector manual, number 95-8751, for instructions regarding **o_i** reflector plate replacement and **o_i** system recalibration.



CAUTION

Do not replace the **o_i** reflector plate without also recalibrating the **o_i** system.

Recalibration of the **oj** system requires the use of the Inspector Connector Cable and Inspector Monitor Software. These two items are included in the **oj** replacement kit, or they can be purchased separately. See the "Ordering Information" section for details.

X3301 oj Reflector Plates

X3301 models are supplied with either a black or a stainless steel **oj** reflector plate. These plates are **not** interchangeable. Order the replacement that matches the **oj** reflector plate on your X3301 Flame Detector.

PERIODIC CHECKOUT PROCEDURE

In compliance with SIL 2, a checkout of the system using the Mag **oj** or Man **oj** feature should be performed regularly to ensure that the system is operating properly. Refer to Table 1 in the X3301 Safety manual, number 95-8720, for frequency of proof tests. To test the system, perform the "Fire Alarm Test" as described in the "Startup Procedure" section of this manual.

CLOCK BATTERY

The real time clock has a backup battery that will operate the clock with no external power. Return the device to the factory for battery replacement if needed.

NOTE

If the backup battery is depleted, there is no effect on the operation of the flame detector, but the time stamping of the data log may be affected.

FEATURES

- Long detection range to carbonaceous fires
- Unequaled false alarm rejection
- Responds to a fire in the presence of modulated blackbody radiation (i.e., heaters, ovens, turbines) without false alarm
- Microprocessor controlled heated optics for increased resistance to moisture and ice
- Automatic, manual, or magnetic **oj** testing
- Easily replaceable **oj** reflector plate
- Fire, fault, and auxiliary relays standard
- 0–20 mA isolated output (optional)
- Eagle Quantum Premier LON/SLC output (optional)
- HART communication (optional)
- FDT/DTM capable

- Multiple sensitivity levels
- A tri-color LED on the detector faceplate indicates normal condition and notifies personnel of fire alarm or fault conditions
- Operates under adverse weather conditions and in dirty environments
- Mounting arm allows easy sighting
- Integral wiring compartment for ease of installation
- Explosion-proof/flame-proof detector housing. Meets FM, CSA, ATEX Directive, and IECEx certification requirements
- Class A wiring per NFPA-72
- Meets NFPA-33 response requirement for under 0.5 second (available when model selected)
- 5 year warranty
- RFI and EMC Directive compliant

Associated Manuals

List of X3301 related manuals:

TITLE	FORM NUMBER
Pulse	95-8736
EQP	95-8533
SIL 2 (Safety)	95-8720
HART Addendum	95-8577
Enhanced Automotive Addendum	95-8787
Hangar	95-8735
Q9033 Mounting Arm and Collar Attachment	95-8686
Enhanced Flame Inspector software for X-Series Flame Detectors	95-8751
Q1130 Flange Mount	95-8662
Q1201 Laser Aimer	95-8404
Q1130 Flange Mount	95-8662
Q1116 Universal Air Shield	95-8597

SPECIFICATIONS

OPERATING VOLTAGE—

24 Vdc nominal (18 Vdc minimum, 30 Vdc maximum). Maximum ripple is 2 volts peak-to-peak.

POWER CONSUMPTION—

Without heater: 4 watts at 24 Vdc nominal;
5.2 watts at 24 Vdc in alarm.
4.5 watts at 30 Vdc nominal;
6.5 watts at 30 Vdc in alarm.
Heater only: 8 watts maximum.
Total power: 17 watts at 30 Vdc with EOL resistor installed and heater on maximum.

For HART model, refer to Addendum number 95-8577.

POWER UP TIME—

Fault indication clears after 0.5 second; device is ready to indicate an alarm condition after 30 seconds.

OUTPUT RELAYS—

Fire Alarm relay. Form C, 5 amperes at 30 Vdc: The Fire Alarm relay has redundant terminals and normally open / normally closed contacts, normally de-energized operation, and latching or non-latching operation.

Fault relay. Form A, 5 amperes at 30 Vdc: The Fault relay has redundant terminals and normally open contacts, normally energized operation, and latching or non-latching operation.

Auxiliary relay. Form C, 5 amperes at 30 Vdc: The auxiliary relay has normally open / normally closed contacts. It is configurable for energized or de-energized operation and latching or non-latching operation to perform as a secondary relay for fire alarm or fault.

CURRENT OUTPUT (OPTIONAL)—

0–20 milliampere (± 0.3 mA) dc current, with a maximum loop resistance of 500 ohms from 18–19.9 Vdc and 600 ohms from 20–30 Vdc.

LON OUTPUT—

Digital communication, transformer isolated (78.5 kbps).

TEMPERATURE RANGE—

Operating: -40°F to $+167^{\circ}\text{F}$ (-40°C to $+75^{\circ}\text{C}$).
Storage: -67°F to $+185^{\circ}\text{F}$ (-55°C to $+85^{\circ}\text{C}$).
Hazardous location ratings from -55°C to $+125^{\circ}\text{C}$.

HUMIDITY RANGE—

0–95% relative humidity, can withstand 100% condensing humidity for short periods of time.

CONE OF VISION—

The detector has a 90° cone of vision (horizontal) with the highest sensitivity lying along the central axis. Unlike conventional detectors, the X3301 provides full coverage at a minimum of 70% of the maximum detection distance.

Perfect cone of vision for methane fire detection — 100 feet (30.5 m) on and off axis on “very high” setting.

Refer to Appendix A for FM Approved cone of vision data.

RESPONSE TIME—

Typical response times are under 10 seconds. Models are available that can respond to automotive paint gun fires in under 0.5 seconds. See Appendix A and the Automotive Addendum, number 95-8787, for actual response times.

DIMENSIONS—

See Figure 20.

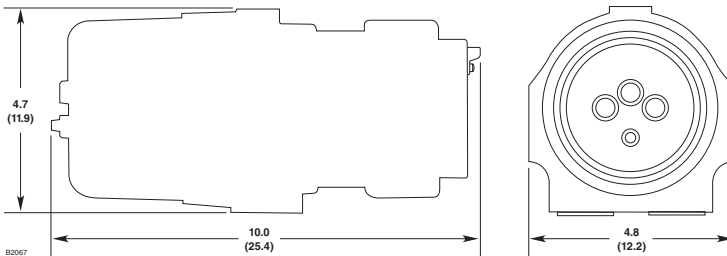

Figure 20—X3301 Dimensions in Inches (cm)

ENCLOSURE MATERIAL—

Copper-free aluminum (painted) or Stainless Steel (316/CF8M Cast).

VIBRATION—

Conformance per FM 3260: 2018, MIL-STD 810C (Curve AW), DNV Note 2.4 (Class B).

WIRING—

Field wiring screw terminals are UL/CSA rated for up to 14 AWG wire, and are DIN/VDE rated for 2.5 mm² wire. Screw terminal required torque range is 3.5–4.4 in.-lbs. (0.4-0.5 N·m).

Important: 18 Vdc minimum must be available at the detector. For ambient temperatures below –10°C (14°F) and above +60°C (140°F) use field wiring suitable for both minimum and maximum ambient temperature.

THREAD SIZE—

Conduit connection: Four entries, 3/4 inch NPT or M25. Conduit seal not required.

SHIPPING WEIGHT (Approximate)—

Aluminum: 7 pounds (3.2 kilograms).
Stainless Steel: 13.8 pounds (6.3 kilograms).
Mounting Arm (AL): 6 pounds (2.75 kilograms).
Mounting Arm (SS): 14 pounds (6.4 kilograms).

WARRANTY PERIOD—

5 years.

CERTIFICATION—



For complete approval details, refer to the appropriate appendix:

- Appendix A - FM
- Appendix B - CSA
- Appendix C - ATEX
- Appendix D - IECEx
- Appendix E - EN54
- Appendix F - Offshore
- Appendix G - Additional Approvals
- Appendix H - Declaration of Conformity

REPLACEMENT PARTS

The detector is not designed to be repaired in the field. If a problem should develop, refer to the "Troubleshooting" section of this manual. If it is determined that the problem is caused by an electronic defect, the device must be returned to the factory for repair.

REPLACEMENT PARTS LIST

Part Number	Description
009208-001	o ₁ Replacement kit for X3301 (5 Black Reflector Plates) with Inspector Connector and Monitor
010831-001	o ₁ Replacement kit for X3301 (5 Stainless Steel Reflector Plates) with Inspector Connector and Monitor
007307-001	Replacement o ₁ Reflector Plates for X3301 with Black plate (requires Inspector Connector to calibrate)
010830-001	Replacement o ₁ Reflector Plates for X3301 with Stainless Steel plate (requires Inspector Connector to calibrate)

NOTE: Refer to instruction manual 95-8530 to determine the correct Replacement o₁ ReflectorPlate.

DEVICE REPAIR AND RETURN

Prior to returning devices, contact the nearest local Detector Electronics office so that a Return Material Identification (RMA) number can be assigned. **A written statement describing the malfunction must accompany the returned device or component to assist and expedite finding the root cause of the failure.**

Pack the unit properly. Always use sufficient packing material. Where applicable, use an antistatic bag as protection from electrostatic discharge.

NOTE

Det-Tronics reserves the right to apply a service charge for repairing returned product damaged as a result of improper packaging.

Return all equipment transportation prepaid to the factory in Minneapolis.

NOTE

It is highly recommended that a complete spare be kept on hand for field replacement to ensure continuous protection.

ORDERING INFORMATION

When ordering, please specify:

X3301 Multispectrum IR Flame Detector

Refer to the X3301 Model Matrix for details

Q9033 Mounting Arm is required:

- Q9033A for aluminum detectors only
- Q9033B for aluminum and stainless steel detectors

ACCESSORIES

Part Number	Description
103881-001	Converter RS485 to USB
007819-002	W6300B1003 USB Inspector Connector (Enhanced Flame Inspector software included)
009207-001	Enhanced Flame Inspector CD
103922-001	Model 475 HART Communicator
102740-002	Magnet
008082-001	Magnet and Adapter for Extension Pole
007739-001	Magnet and Extension Pole
007240-001	Q1116A1001, Air Shield (AL)
007818-001	Q1118A1001 Aluminum Air Shield/Flange Mount (AL)
007818-002	Q1118S1001 Stainless Steel Air Shield/Flange Mount (SS)
009177-001	Q1120A1001 Paint Shield mounting ring (AL)
010857-001	Q1130A1001 Flange Mount Assembly
006097-002	Q1201 Green Laser
102871-001	Laser Battery, 3V Lithium (laser)
007255-001	Q1201C1001 X-Series Laser Holder (AL/Plastic)
007338-001	Q2000A1001 X-Series Weather Shield (AL)
007338-010	Q2033A10R X3301/X3302 FOV Limiter 10° (AL)
007338-020	Q2033A20R X3301/X3302 FOV Limiter 20° (AL)
007338-030	Q2033A30R X3301/X3302 FOV Limiter 30° (AL)
007912-010	Spare Restrictor Plate 10° (AL)
007912-020	Spare Restrictor Plate 20° (AL)
007912-030	Spare Restrictor Plate 30° (AL)
007290-001	Q9033B Stainless Steel Mounting Arm Assembly is for aluminum and stainless steel detectors
007290-002	Q9033A Aluminum Mounting Arm Assembly is for aluminum detectors only
011385-001	Q9033 Collar Attachment
101197-001	Stop Plug, 3/4" NPT, AL
101197-004	Stop Plug, 3/4" NPT, SS
101197-005	Stop Plug, M25, AL, IP66
101197-003	Stop Plug, M25, SS, IP66
010816-001	Stop Plug, 20 Pack, 3/4"NPT, AL
010817-001	Stop Plug, 20 Pack, 3/4"NPT, SS
010818-001	Stop Plug, 20 Pack, M25, AL, IP66
010819-001	Stop Plug, 20 Pack, M25, SS, IP66
103363-001	14 mm Hex Wrench (Steel)
103406-001	Screwdriver
001680-001	Window cleaner (6 pack)
107427-040	O-ring - Rear Cover (Viton) - black or brown
005003-001	1 oz grease for detectors (silicone-free)
104346-154	O-ring - Rear Cover (Fluorosilicone) - blue
012549-001	1 oz PTFE silicone-free lubricant
000003-067	Stainless Steel Sun Shade
000609-026	4" Pipe Mount Bracket and U-Bolt Kit
000609-035	2" Pipe Mount U-Bolt Kit

X3301 MODEL MATRIX

MODEL	DESCRIPTION	
X3301	Multispectrum IR Flame Detector	
	TYPE	MATERIAL
	A	Aluminum
	S	Stainless Steel (316)
	TYPE	THREAD TYPE
	4M	4 Port, Metric M25
	4N	4 Port, 3/4" NPT
	TYPE	OUTPUTS
	11	Relay
	13	Relay and 0-20 mA
	14	Eagle Quantum Premier (EQP)
	15	Relay and Pulse
	21	Relay-Automotive
	22	EQP Automotive
	23	HART, Relay and 0-20 mA
	TYPE	APPROVALS*
	B	INMETRO (Brazil)
	R	VNIIP0/VNIIFTRI (Russia)
	T	SIL/FM/CSA/QPS**/ATEX/IECEX
	W	FM/CSA/QPS**/ATEX/IECEX
	TYPE	CLASSIFICATION
	1	Division/Zone Ex d e
	2	Division/Zone Ex d

*Type Approvals can use one or more letters to designate the approvals of the product.

**QPS approval applies to output types 11, 13, 15, 21, and 23.

HIGH RESOLUTION FIELD OF VIEW DIAGRAMS

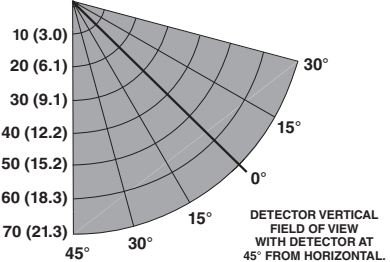
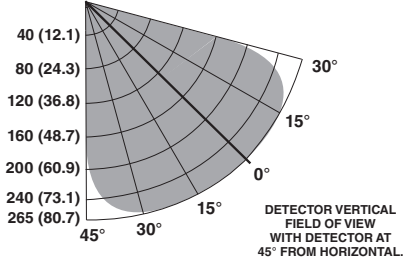
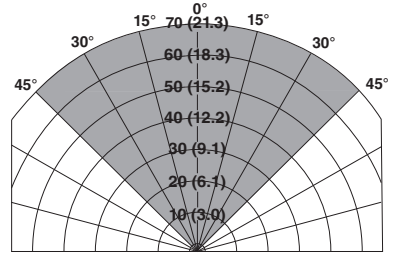
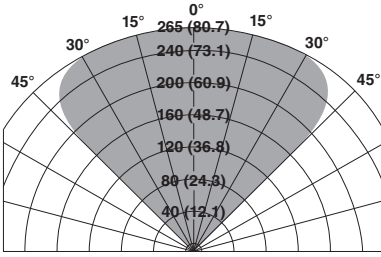

Field of View at Indicated Distance in Feet (m) for **n-Heptane** at **Very High Sensitivity** (1 x 1 foot)

Field of View at Indicated Distance in Feet (m) for **Isopropanol** at **Very High Sensitivity** (6 in. x 6 in.)

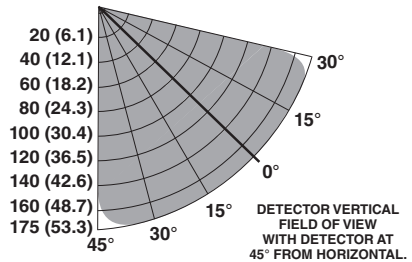
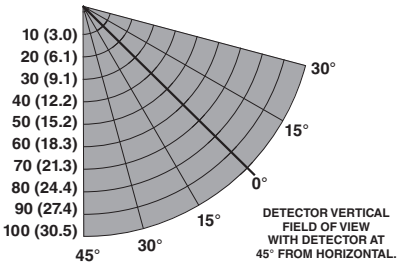
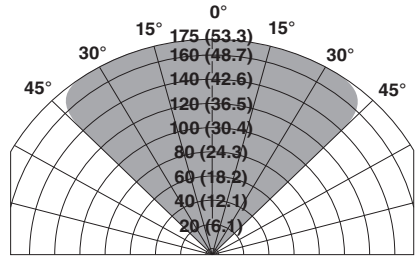
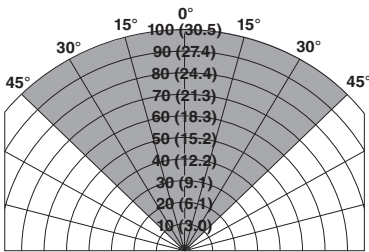

Field of View at Indicated Distance in Feet (m) for **n-Heptane** at **Very High Sensitivity** (6 in. x 6 in.)

Field of View at Indicated Distance in Feet (m) for **Diesel** at **Very High Sensitivity** (1 x 1 foot)

High Resolution Field of View Diagrams – Continued

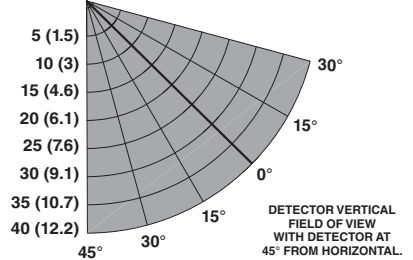
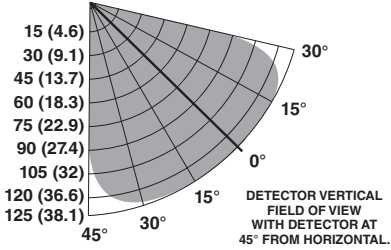
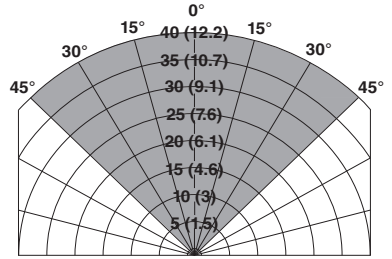
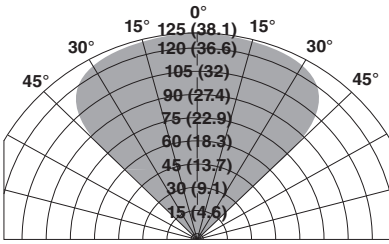

Field of View at Indicated Distance in Feet (m) for
Propane at Very High Sensitivity (32 inch plume)

Field of View at Indicated Distance in Feet (m) for
Methanol at Very High Sensitivity (6 in. x 6 in.)

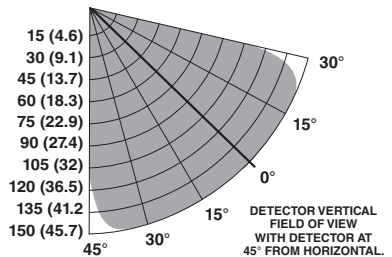
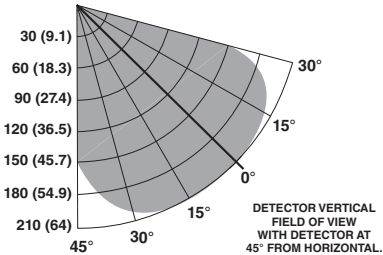
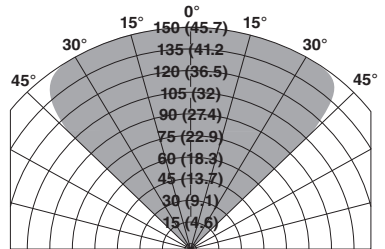
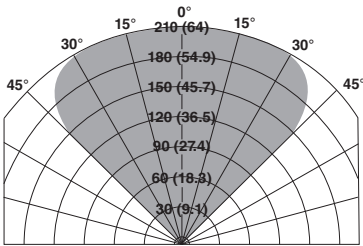

Field of View at Indicated Distance in Feet (m) for
Ethanol at Very High Sensitivity (1 x 1 foot)

Field of View at Indicated Distance in Feet (m) for
Methanol at Very High Sensitivity (1 x 1 foot)

High Resolution Field of View Diagrams – Continued

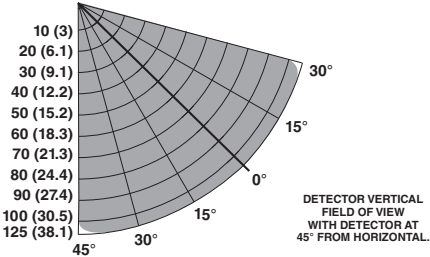
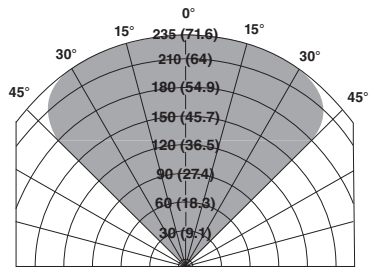
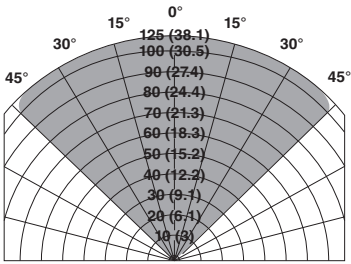

Field of View at Indicated Distance in Feet (m) for
Methane at Very High Sensitivity (32 inch plume)

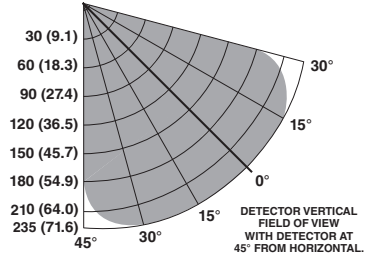

Field of View at Indicated Distance in Feet (m) for
JP-5 at Very High Sensitivity (2 x 2 feet)

High Resolution Field of View Diagrams – Continued

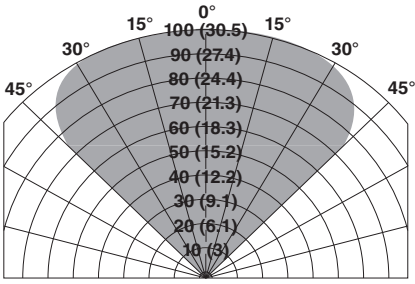

Field of View at Indicated Distance in Feet (m) for **n-Heptane** at Medium Sensitivity (1 x 1 foot)

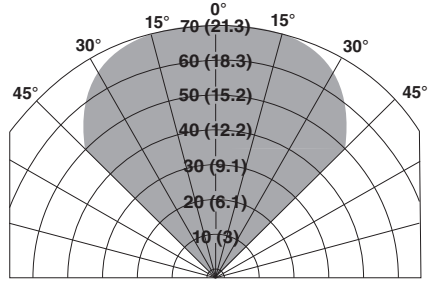

Field of View at Indicated Distance in Feet (m) for **Methanol** at Medium Sensitivity (1 x 1 foot)

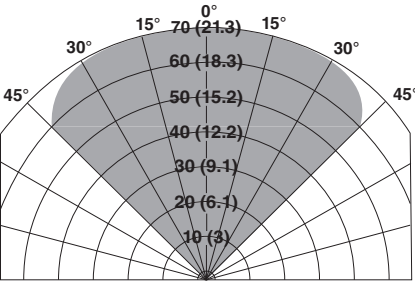

Field of View at Indicated Distance in Feet (m) for **Diesel** at Medium Sensitivity (1 x 1 foot)

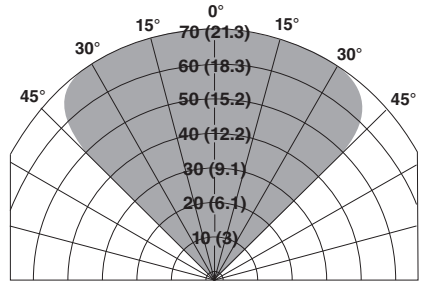

Field of View at Indicated Distance in Feet (m) for **Methane** at Medium Sensitivity (32 inch plume)

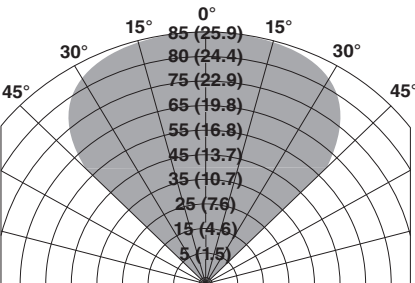

Field of View at Indicated Distance in Feet (m) for **Ethanol** at Medium Sensitivity (1 x 1 foot)

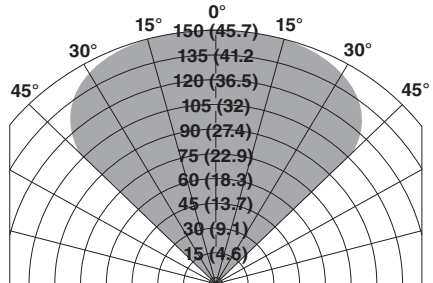

Field of View at Indicated Distance in Feet (m) for **JP-5** at Medium Sensitivity (2 x 2 feet)

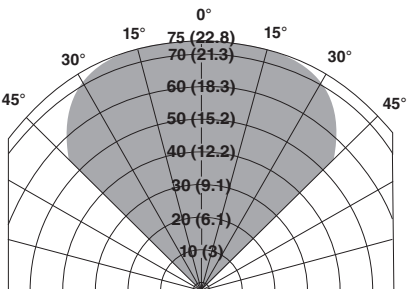

Field of View at Indicated Distance in Feet (m) for **Propane** at Medium Sensitivity (32 inch plume)

APPENDIX A

FM APPROVAL AND PERFORMANCE REPORT

THE FOLLOWING ITEMS, FUNCTIONS, AND OPTIONS DESCRIBE THE FM APPROVAL:

- Explosion-proof for Class I, Div. 1, Groups B, C, and D (T4A) Hazardous (Classified) Locations per FM 3615.
- Dust-ignition proof for Class II/III, Div. 1, Groups E, F, and G (T4A) Hazardous (Classified) Locations per FM 3615.
- Nonincendive for Class I, Div. 2, Groups A, B, C, and D (T3C) Hazardous (Classified) Locations per FM 3611.
- Nonincendive for Class II, Div. 2, Groups F and G (T3C) Hazardous (Classified) Locations per FM 3611.
- Enclosure rating NEMA/Type 4X per NEMA 250.
- Ambient Temperature Limits: -40°F to +167°F (-40°C to +75°C).
- Automatic Fire Alarm Signaling Performance verified per FM 3260 (2018).

Flameproof per ANSI/ISA 60079-0, -1, -7, -31

Class I, Zone 1, AEx db eb IIC T6...T5

T6 (Tamb -40°C to +60°C)

T5 (Tamb -40°C to +75°C)

Zone 21, AEx tb IIIC T130°C

Tamb -40°C to +75°C

IP66

Class I, Zone 1, AEx db IIC T6...T5

T6 (Tamb -40°C to +60°C)

T5 (Tamb -40°C to +75°C)

IP66/IP67

The following accessories are FM approved for use with the X3301 Flame Detector:

Part Number	Description
102740-002	Magnet
007739-001	Magnet and Extension Pole
010857-001	Q1130A1001 Flange Mount Assembly
007290-001	Q9033B Stainless Steel Mounting Arm Assembly is for aluminum and stainless steel detectors
007290-002	Q9033A Aluminum Mounting Arm Assembly is for aluminum detectors only
011385-001	Q9033 Collar Attachment

The following performance criteria were verified:

AUTOMATIC OPTICAL INTEGRITY TEST:

The detector generated an optical fault in the presence of contamination on any single or combination of lens surfaces resulting in a loss of approximately 50% of its detection range, verifying that the detector performs a calibrated Automatic **oi** test for each sensor. Upon removal of the contamination, the detector fault was cleared and the detector was verified to detect a fire.

MANUAL OPTICAL INTEGRITY TEST:

The Manual / Magnetic **oi** performs the same calibrated test as the Automatic **oi**, and additionally actuates the alarm relay to verify output operation. If there is a 50% loss of its detection range, an alarm signal is not generated.

The **oi** test procedure, as described in the "Magnetic **oi** / Manual **oi**" section of this instruction manual, is the approved external optical test method for this detector to verify end-to-end detector function. This test replaces the function and need of a traditional external test lamp.

FM Approval and Performance Report – Continued

RESPONSE CHARACTERISTICS

Very High Sensitivity

Fuel	Size	Distance feet (m)	Average Response Time (seconds)***
n-Heptane	1 x 1 foot	265 (80.7)*	22
	1 x 1 foot	250 (76.2)	17
	1 x 1 foot	100 (30.5)	3
	6 in. x 6 in.	100 (30.5)	7
Gasoline	1 x 1 foot	250 (76.2)	6
Kerosene	1 x 1 foot	150 (45.7)	7**
Isopropanol	6 in. x 6 in.	70 (21.3)	6
Diesel	1 x 1 foot	175 (53.3)	6**
Ethanol	1 x 1 foot	210 (64.0)	11
Methanol	6 in. x 6 in.	40 (12.2)	3
	1 x 1 foot	150 (45.7)	7
	1 x 1 foot	150 (45.7)	5**
Xylene	1 x 1 foot	200 (60.9)	8**
Toluene	1 x 1 foot	200 (60.9)	7**
Methane	32 inch plume	125 (38.1)	5
Propane	32 inch plume	125 (38.1)	5
Ethane	32 inch plume	125 (38.1)	5
Ethylene	32 inch plume	125 (38.1)	8
Butane	32 inch plume	125 (38.1)	5
Jet A	1 x 1 foot	150 (45.7)	4**
JP-5	2 x 2 feet	235 (71.6)	3**
JP-8	1 x 1 foot	150 (45.7)	5**
Class A	Ø12 in. x 7 in.	150 (45.7)	3**

* Outdoor test condition

** Pre-burn from ignition

*** Add 2 seconds for EQP model

Ø Diameter

Medium Sensitivity

Fuel	Size	Distance feet (m)	Average Response Time (seconds)***
n-Heptane	1 x 1 foot	100 (30.5)	7
	1 x 1 foot	50 (15.24)	<2
Isopropanol	6 in. x 6 in.	45 (13.72)	7
Diesel	1 x 1 foot	70 (21.3)	4**
Ethanol	1 x 1 foot	85 (25.9)	7
Methanol	1 x 1 foot	70 (21.3)	6
Methane	32 inch plume	70 (21.3)	6
	32 inch plume	55 (16.7)	4
Propane	32 inch plume	75 (22.8)	<5
Ethane	32 inch plume	75 (22.8)	5
Ethylene	32 inch plume	75 (22.8)	6
Butane	32 inch plume	75 (22.8)	4
JP-5	2 x 2 feet	150 (45.7)	3**
Class A	Ø12 in. x 7 in.	50 (15.24)	4**

** Pre-burn from ignition

*** Add 2 seconds for EQP model

Ø Diameter

FM Approval and Performance Report – Continued

T-Low Sensitivity

Fuel	Size	Distance feet (m)	Average Response Time (seconds)***
n-Heptane	1 x 1 foot	50 (15.24)	<4
Methanol	1 x 1 foot	30 (9.14)	5
Methane	32 inch plume	30 (9.14)	3
Propane	32 inch plume	30 (9.14)	5

*** Add 2 seconds for EQP model

Low Sensitivity

Fuel	Size	Distance feet (m)	Average Response Time (seconds)***
n-Heptane	1 x 1 foot	50 (15.24)	<10
Methanol	1 x 1 foot	30 (9.14)	10
Methane	32 inch plume	30 (9.14)	10
Propane	32 inch plume	30 (9.14)	9

*** Add 2 seconds for EQP model

FM Approval and Performance Report – Continued

RESPONSE CHARACTERISTICS IN THE PRESENCE OF FALSE ALARM SOURCES

Very High Sensitivity

False Alarm Source	Distance feet (m)	Fire Source	Distance feet (m)	Average Response Time (seconds)***
Sunlight, direct, modulated, reflected	—	6-inch propane	6 (1.8)	12
Sunlight, direct, unmodulated, reflected	—	6-inch propane	6 (1.8)	2
Radio frequency interference	1 (0.3)	3-inch propane	12 (3.7)	<10
Arc welding, #7014	40 (12.2)	1 x 1 foot n-Heptane	40 (12.2)	3 unmodulated / 2 modulated
LED Lamp, modulated	5 (1.5)	1 x 1 foot n-Heptane	210 (64)	6
LED Lamp, unmodulated	5 (1.5)	1 x 1 foot n-Heptane	210 (64)	7
70 w sodium vapor lamp, modulated	3 (0.9)	1 x 1 foot n-Heptane	80 (24.4)	3
70 w sodium vapor lamp, unmodulated	3 (0.9)	1 x 1 foot n-Heptane	80 (24.4)	3
250 w vapor lamp, modulated	3 (0.9)	1 x 1 foot n-Heptane	80 (24.4)	4
250 w vapor lamp, unmodulated	3 (0.9)	1 x 1 foot n-Heptane	80 (24.4)	3
300 w incandescent lamp, modulated	3 (0.9)	1 x 1 foot n-Heptane	80 (24.4)	9
300 w incandescent lamp, unmodulated	3 (0.9)	1 x 1 foot n-Heptane	80 (24.4)	3
500 w shielded quartz halogen lamp, modulated	8 (2.4)	1 x 1 foot n-Heptane	80 (24.4)	4
500 w shielded quartz halogen lamp, unmodulated	8 (2.4)	1 x 1 foot n-Heptane	80 (24.4)	3
500 w unshielded quartz halogen lamp, modulated	8 (2.4)	1 x 1 foot n-Heptane	80 (24.4)	3
500 w unshielded quartz halogen lamp, unmodulated	8 (2.4)	1 x 1 foot n-Heptane	80 (24.4)	3
1500 w electric radiant heater, modulated	10 (3.0)	1 x 1 foot n-Heptane	80 (24.4)	3
1500 w electric radiant heater, unmodulated	10 (3.0)	1 x 1 foot n-Heptane	80 (24.4)	3
Two 34 w fluorescent lamps, modulated	3 (0.9)	1 x 1 foot n-Heptane	80 (24.4)	3
Two 34 w fluorescent lamps, unmodulated	3 (0.9)	1 x 1 foot n-Heptane	80 (24.4)	3

*** Add 2 seconds for EQP model

Medium Sensitivity

False Alarm Source	Distance feet (m)	Fire Source	Distance feet (m)	Average Response Time (seconds)***
Sunlight, direct, modulated, reflected	—	6-inch propane	6 (1.8)	9
Sunlight, direct, unmodulated, reflected	—	6-inch propane	6 (1.8)	5
Radio frequency interference	1 (0.3)	6-inch propane	6 (1.8)	<1
Arc welding, #7014	15 (4.57)	1 x 1 foot n-Heptane	40 (12.2)	2 modulated
LED Lamp, modulated	3 (0.9)	1 x 1 foot n-Heptane	100 (30.5)	9
LED Lamp, unmodulated	3 (0.9)	1 x 1 foot n-Heptane	100 (30.5)	7
70 w sodium vapor lamp, modulated	3 (0.9)	1 x 1 foot n-Heptane	60 (18.3)	4
70 w sodium vapor lamp, unmodulated	3 (0.9)	1 x 1 foot n-Heptane	60 (18.3)	3
250 w vapor lamp, modulated	3 (0.9)	1 x 1 foot n-Heptane	60 (18.3)	3
250 w vapor lamp, unmodulated	3 (0.9)	1 x 1 foot n-Heptane	60 (18.3)	4
300 w incandescent lamp, modulated	3 (0.9)	1 x 1 foot n-Heptane	60 (18.3)	9
300 w incandescent lamp, unmodulated	3 (0.9)	1 x 1 foot n-Heptane	60 (18.3)	4
500 w shielded quartz halogen lamp, modulated	8 (2.4)	1 x 1 foot n-Heptane	60 (18.3)	6
500 w shielded quartz halogen lamp, unmodulated	8 (2.4)	1 x 1 foot n-Heptane	60 (18.3)	4
500 w unshielded quartz halogen lamp, modulated	8 (2.4)	1 x 1 foot n-Heptane	60 (18.3)	5
500 w unshielded quartz halogen lamp, unmodulated	8 (2.4)	1 x 1 foot n-Heptane	60 (18.3)	4
1500 w electric radiant heater, modulated	10 (3.0)	1 x 1 foot n-Heptane	60 (18.3)	6
1500 w electric radiant heater, unmodulated	10 (3.0)	1 x 1 foot n-Heptane	60 (18.3)	4
Two 34 w fluorescent lamps, modulated	3 (0.9)	1 x 1 foot n-Heptane	60 (18.3)	4
Two 34 w fluorescent lamps, unmodulated	3 (0.9)	1 x 1 foot n-Heptane	60 (18.3)	4

*** Add 2 seconds for EQP model

FM Approval and Performance Report – Continued

T-Low Sensitivity

False Alarm Source	Distance feet (m)	Fire Source	Distance feet (m)	Average Response Time (seconds)***
Sunlight, direct, modulated, reflected*	—	1 x 1 foot n-Heptane	15 (4.6)	8
Sunlight, direct, unmodulated, reflected*	—	1 x 1 foot n-Heptane	35 (10.7)	9
Arc welding, modulated, #7014	8 (2.4)	1 x 1 foot n-Heptane	30 (9.1)	3
LED Lamp, modulated	3 (0.9)	1 x 1 foot n-Heptane	50 (15.24)	2
LED Lamp, unmodulated	3 (0.9)	1 x 1 foot n-Heptane	50 (15.24)	3
70 w sodium vapor, modulated	3 (0.9)	1 x 1 foot n-Heptane	50 (15.24)	5
70 w sodium vapor, unmodulated	3 (0.9)	1 x 1 foot n-Heptane	50 (15.24)	4
250 w vapor lamp, modulated	3 (0.9)	1 x 1 foot n-Heptane	50 (15.24)	5
250 w vapor lamp, unmodulated	3 (0.9)	1 x 1 foot n-Heptane	50 (15.24)	6
300 w incandescent lamp, modulated	3 (0.9)	1 x 1 foot n-Heptane	50 (15.24)	6
300 w incandescent lamp, unmodulated	3 (0.9)	1 x 1 foot n-Heptane	50 (15.24)	4
500 w shielded quartz halogen lamp, modulated	10 (3.0)	1 x 1 foot n-Heptane	50 (15.24)	5
500 w shielded quartz halogen lamp, unmodulated	3 (0.9)	1 x 1 foot n-Heptane	50 (15.24)	5
1500 w electric radiant heater, modulated	10 (3.0)	1 x 1 foot n-Heptane	50 (15.24)	5
1500 w electric radiant heater, unmodulated	3 (0.9)	1 x 1 foot n-Heptane	50 (15.24)	3
Two 34 w fluorescent lamps, modulated	3 (0.9)	1 x 1 foot n-Heptane	50 (15.24)	6
Two 34 w fluorescent lamps, unmodulated	3 (0.9)	1 x 1 foot n-Heptane	50 (15.24)	2

* Outdoor test conditions

*** Add 2 seconds for EQP model

Low Sensitivity

False Alarm Source	Distance feet (m)	Fire Source	Distance feet (m)	Average Response Time (seconds)***
Sunlight, direct, modulated, reflected*	—	1 x 1 foot n-Heptane	15 (4.6)	19
Sunlight, direct, unmodulated, reflected*	—	1 x 1 foot n-Heptane	35 (10.7)	12
Arc welding, modulated, #7014	5 (1.5)	1 x 1 foot n-Heptane	30 (9.1)	10
LED Lamp, modulated	3 (0.9)	1 x 1 foot n-Heptane	50 (15.24)	9
LED Lamp, unmodulated	3 (0.9)	1 x 1 foot n-Heptane	50 (15.24)	12
70 w sodium vapor, modulated	3 (0.9)	1 x 1 foot n-Heptane	50 (15.24)	11
250 w vapor lamp, modulated	5 (1.5)	1 x 1 foot n-Heptane	50 (15.24)	11
300 w incandescent lamp, modulated	5 (1.5)	1 x 1 foot n-Heptane	50 (15.24)	11
500 w shielded quartz halogen lamp, modulated	10 (3.0)	1 x 1 foot n-Heptane	50 (15.24)	10
500 w shielded quartz halogen lamp, unmodulated	3 (0.9)	1 x 1 foot n-Heptane	50 (15.24)	10
1500 w electric radiant heater, modulated	10 (3.0)	1 x 1 foot n-Heptane	50 (15.24)	12
1500 w electric radiant heater, unmodulated	3 (0.9)	1 x 1 foot n-Heptane	50 (15.24)	8
Two 34 w fluorescent lamps, modulated	3 (0.9)	1 x 1 foot n-Heptane	50 (15.24)	10

* Outdoor test conditions

*** Add 2 seconds for EQP model

FM Approval and Performance Report – Continued

FALSE ALARM IMMUNITY

Very High Sensitivity

False Alarm Source	Distance feet (m)	Modulated Response	Unmodulated Response
Sunlight, direct, reflected	—	No alarm	No alarm
Vibration	N/A	No alarm	N/A
Radio frequency interference	1 (0.3)	No alarm (keyed)	No alarm (steady)
Arc welding	40 (12.2)	No alarm	No alarm
LED Lamp	5 (1.5)	No alarm	No alarm
70 w sodium vapor lamp	3 (0.9)	No alarm	No alarm
250 w vapor lamp	3 (0.9)	No alarm	No alarm
300 w incandescent lamp	3 (0.9)	No alarm	No alarm
500 w unshielded quartz halogen lamp	8 (2.4)	No alarm	No alarm
500 w shielded quartz halogen lamp	8 (2.4)	No alarm	No alarm
1500 w electric radiant heater	3 (0.9)	No alarm	No alarm
Two 34 w fluorescent lamps	5 (1.5)	No alarm	No alarm

Medium Sensitivity

False Alarm Source	Distance feet (m)	Modulated Response	Unmodulated Response
Sunlight, direct, reflected	—	No alarm	No alarm
Vibration	N/A	No alarm	N/A
Radio frequency interference	1 (0.3)	No alarm (keyed)	No alarm (steady)
Arc welding	10 (3)	No alarm	No alarm
LED Lamp	3 (0.9)	No alarm	No alarm
70 w sodium vapor lamp	3 (0.9)	No alarm	No alarm
250 w vapor lamp	3 (0.9)	No alarm	No alarm
300 w incandescent lamp	3 (0.9)	No alarm	No alarm
500 w unshielded quartz halogen lamp	3 (0.9)	No alarm	No alarm
500 w shielded quartz halogen lamp	3 (0.9)	No alarm	No alarm
1500 w electric radiant heater	3 (0.9)	No alarm	No alarm
Two 34 w fluorescent lamps	3 (0.9)	No alarm	No alarm

T-Low Sensitivity

False Alarm Source	Distance feet (m)	Modulated Response	Unmodulated Response
Sunlight, direct, reflected	—	No alarm	No alarm
Vibration	N/A	No alarm	No alarm
Arc welding	5 (1.5)	No alarm	No alarm
LED Lamp	3 (0.9)	No alarm	No alarm
70 w sodium vapor	3 (0.9)	No alarm	No alarm
250 w vapor lamp	3 (0.9)	No alarm	No alarm
300 w incandescent lamp	3 (0.9)	No alarm	No alarm
500 w shielded quartz halogen lamp	3 (0.9)	No alarm	No alarm
500 w unshielded quartz halogen lamp	3 (0.9)	No alarm	No alarm
1500 w electric radiant heater	3 (0.9)	No alarm	No alarm
Two 34 w fluorescent lamps	3 (0.9)	No alarm	No alarm

FM Approval and Performance Report – Continued

Low Sensitivity

False Alarm Source	Distance feet (m)	Modulated Response	Unmodulated Response
Sunlight, direct, reflected	—	No alarm	No alarm
Vibration	N/A	No alarm	No alarm
Radio frequency interference	—	No alarm	N/A
Arc welding	5 (1.5)	No alarm	No alarm
LED Lamp	3 (0.9)	No alarm	No alarm
70 w sodium vapor lamp	3 (0.9)	No alarm	No alarm
250 w vapor lamp	3 (0.9)	No alarm	No alarm
300 w incandescent lamp	3 (0.9)	No alarm	No alarm
500 w shielded quartz halogen lamp	3 (0.9)	No alarm	No alarm
500 w unshielded quartz halogen lamp	3 (0.9)	No alarm	No alarm
1500 w electric radiant heater	3 (0.9)	No alarm	No alarm
Two 34 w fluorescent lamps	3 (0.9)	No alarm	No alarm

FIELD OF VIEW

Very High Sensitivity

Fuel	Size	Distance feet (m)	Horizontal L, R (°)	Avg. Resp Time (s) ^{***}	Vertical Down (°)	Avg. Resp Time (s) ^{***}	Vertical Up (°)	Avg. Resp Time (s) ^{***}
n-Heptane	1 x 1 foot	190 (57.9)	+/- 45	11	+45	11	-30	8
	1 x 1 foot	180 (54.9)	+/- 45	8	+45	11	-30	3
	1 x 1 foot	180 (54.9)	+/- 45	6**	+45	6**	-30	3**
	1 x 1 foot	100 (30.5)	+/- 45	4	+45	3	-30	2
	6 x 6 inches	100 (30.5)	+/- 45	11	+45	11	-30	7
Gasoline	1 x 1 foot	190 (57.9)	+/- 45	7	+45	9	-30	5
Kerosene	1 x 1 foot	110 (33.5)	+/- 45	5	+45	5	-30	4
Isopropanol	6 x 6 inches	70 (21.3)	+/- 45	8	+45	6	-30	5
Diesel	1 x 1 foot	150 (45.7)	+/- 45	10**	+45	7**	-30	7**
Ethanol	1 x 1 foot	150 (45.7)	+/- 45	15	+45	13	-30	10
Methanol	6 x 6 inches	40 (12.2)	+/- 45	3	+45	3	-30	2
	1 x 1 foot	110 (33.5)	+/- 45	8	+45	13	-30	3
	1 x 1 foot	110 (33.5)	+/- 45	8**	+45	4**	-30	3**
Xylene	1 x 1 foot	150 (45.7)	+/- 45	7**	+45	6**	-30	3**
Toluene	1 x 1 foot	150 (45.7)	+/- 45	8**	+45	8**	-30	4**
Methane	32 inch plume	100 (30.5)	+/- 45	7	+45	8	-30	4
Propane	32 inch plume	90 (27.4)	+/- 45	7	+45	9	-30	5
Ethane	32 inch plume	90 (27.4)	+/- 45	5	+45	6	-30	3
Ethylene	32 inch plume	90 (27.4)	+/- 45	7	+45	9	-30	5
Butane	32 inch plume	90 (27.4)	+/- 45	5	+45	4	-30	2
Jet A	1 x 1 foot	100 (30.5)	+/- 45	4**	+45	3**	-30	2**
JP-5	2 x 2 feet	180 (54.9)	+/- 45	6**	+45	4**	-30	2**
JP-8	1 x 1 foot	100 (30.5)	+/- 45	5**	+45	5**	-30	3**
Class A	Ø12 in. x 7 in.	80 (24.4)	+/- 45	4**	+45	2**	-30	2**

* Outdoor test condition

** Pre-burn from ignition

*** Add 2 seconds for EQP model

Ø Diameter

FM Approval and Performance Report – Continued

Medium Sensitivity

Fuel	Size	Distance feet (m)	Horizontal L, R (°)	Avg. Resp Time (s)***	Vertical Down (°)	Avg. Resp Time (s)***	Vertical Up (°)	Avg. Resp Time (s)***
n-Heptane	1 x 1 foot	75 (22.9)	+/- 45	5	+45	4	-30	5
	1 x 1 foot	50 (15.2)	+/- 45	3	+45	2	-30	3
Isopropanol	6 x 6 inches	45 (13.7)	+/- 45	11	+45	8	-30	6
Diesel	1 x 1 foot	60 (18.2)	+/- 45	4**	+45	6**	-30	4**
Ethanol	1 x 1 foot	60 (18.2)	+/- 45	7	+45	8	-30	5
Methanol	1 x 1 foot	50 (15.2)	+/- 45	5	+45	2	-30	6
Methane	32 inch plume	50 (15.2)	+/- 45	5	+45	6	-30	3
Propane	32 inch plume	55 (16.7)	+/- 45	5	+45	4	-30	5
Ethane	32 inch plume	55 (16.7)	+/- 45	6	+45	5	-30	5
Ethylene	32 inch plume	55 (16.7)	+/- 45	7	+45	5	-30	5
Butane	32 inch plume	55 (16.7)	+/- 45	6	+45	4	-30	3
JP-5	2 x 2 feet	110 (33.5)	+/- 45	7**	+45	4**	-30	5**
Class A	Ø12 in. x 7 in.	40 (12.2)	+/- 45	3**	+45	3**	-30	3**

** Pre-burn from ignition

*** Add 2 seconds for EQP model

Ø Diameter

T-Low Sensitivity

Fuel	Size	Distance feet (m)	Horizontal L, R (°)	Avg. Resp Time (s)***	Vertical Down (°)	Avg. Resp Time (s)***	Vertical Up (°)	Avg. Resp Time (s)***
n-Heptane	1 x 1 foot	35 (10.7)	+/- 45	4	+45	4	-30	3
Methanol	1 x 1 foot	20 (6.1)	+/- 45	4	+45	4	-30	2
Methane	32 inch plume	20 (6.1)	+/- 45	4	+45	4	-30	4
Propane	32 inch plume	20 (6.1)	+/- 45	4	+45	4	-30	5

*** Add 2 seconds for EQP model.

Low Sensitivity

Fuel	Size	Distance feet (m)	Horizontal L, R (°)	Avg. Resp Time (s)***	Vertical Down (°)	Avg. Resp Time (s)***	Vertical Up (°)	Avg. Resp Time (s)***
n-Heptane	1 x 1 foot	35 (10.7)	+/- 45	8	+45	9	-30	10
Methanol	1 x 1 foot	20 (6.1)	+/- 45	9	+45	9	-30	9
Methane	32 inch plume	20 (6.1)	+/- 45	9	+45	9	-30	8
Propane	32 inch plume	20 (6.1)	+/- 45	9	+45	9	-30	11

*** Add 2 seconds for EQP model.

APPENDIX B

CSA APPROVAL

DIVISION CLASSIFICATION:

Multispectrum IR Flame Detector/Controller X3301 Series, rated 18–30 Vdc, 4.6–17 Watts.
Relay contacts rated 30 Vdc, 5 Amps.

CLASS 4818 04 - SIGNAL APPLIANCES - Systems - For Hazardous Locations

Class I, Division 1, Groups B, C, and D (T4A); Class II, Division 1, Groups E, F, and G (T4A);
Class I, Division 2, Groups A, B, C, and D (T3C); Class II, Division 2, Groups F and G (T3C);
Class III; Enclosure NEMA/Type 4X;
Conduit seal not required.

APPLICABLE REQUIREMENTS

- CAN/CSA-C22.2 No. 0-M91 – General Requirements — Canadian Electrical Code, Part II
- CAN/CSA-C22.2 No. 25-1966 – Enclosures for use in Class II Groups E, F, and G Hazardous Locations
- CAN/CSA-C22.2 No. 30-M1986 – Explosion-Proof Enclosures for use in Class I Hazardous Locations
- CAN/CSA-C22.2 No. 94-M91 – Special Purpose Enclosures
- CAN/CSA-C22.2 No. 142-M1987 – Process Control Equipment
- CAN/CSA-C22.2 No. 213-M1987 – Nonincendive Electrical Equipment for use in Class I, Division 2 Hazardous Locations

ZONE CLASSIFICATION:

CLASS 4818 04 - SIGNAL APPLIANCES - Systems - For Hazardous Locations

Ex db eb IIC T6...T5

T6 (Tamb = -50°C to +60°C)

T5 (Tamb = -50°C to +75°C)

Ex tb IIIC T130°C

(Tamb = -50°C to +75°C)

Seal required adjacent to enclosure

IP66

Ex db IIC T6...T5

T6 (Ta -55°C to +60°C)

T5 (Ta -55°C to +75°C)

Seal required adjacent to enclosure

IP66/IP67

APPLICABLE REQUIREMENTS

- CAN/CSA-C22.2 No. 60079-0:2015 – Electrical apparatus for explosive gas atmospheres. Part 0: General requirements
- CAN/CSA-C22.2 No. 60079-1:2016 – Explosive atmospheres. Part 1: Equipment protection by flameproof enclosures "d"
- CAN/CSA-C22.2 No. 60079-7:2012 – Explosive atmospheres. Part 7: Equipment protection by increased safety "e"
- CAN/CSA-C22.2 No. 60079-31:2015 – Explosive atmospheres. Part 31: Equipment dust ignition protection by enclosure "t"

The following accessories are CSA approved for use with the X3301 Flame Detector:

Part Number	Description
102740-002	Magnet
007739-001	Magnet and Extension Pole
010857-001	Q1130A1001 Flange Mount Assembly
007290-001	Q9033B Stainless Steel Mounting Arm Assembly is for aluminum and stainless steel detectors
007290-002	Q9033A Aluminum Mounting Arm Assembly is for aluminum detectors only
011385-001	Q9033 Collar Attachment

APPENDIX C

ATEX APPROVAL

EC-TYPE EXAMINATION CERTIFICATE

DEMKO 01 ATEX 130204X

Increased Safety Model

CE 0539 

Ex db eb IIC T6...T5 Gb

Ex tb IIIC T130°C Db

T6 (Tamb = -50°C to +60°C)

T5 (Tamb = -50°C to +75°C)

IP66

Flameproof Model

CE 0539 

Ex db IIC T6...T4 Gb

T6 (Tamb = -55°C to +60°C)

T5 (Tamb = -55°C to +75°C)

T4 (Tamb = -55°C to +125°C)

IP66/IP67

Compliance with:

EN 60079-0: 2012+A11:2013

EN 60079-1: 2014

EN 60079-7: 2015

EN 60079-31: 2014

EN 60529: 1991+A1:2000+A2:2013

INSTALLATION INSTRUCTIONS

The field wiring connections in the terminal compartment are ATEX certified and accepts wiring specifications from 14-24 AWG, 2.5-0.2 mm².

The Multispectrum infrared (IR) flame detector type X3301 shall be installed according to the instructions given by the manufacturer.

The cable entry devices shall be certified in type of explosion protection flameproof enclosure "d" for use with the terminal compartment in type of explosion protection flameproof enclosure "d," or in type of explosion protection increased safety "e" for use with the terminal compartment in type of explosion protection increased safety "e." They shall be IP66 rated, suitable for the conditions of use and correctly installed.

Unused entries shall be closed with suitable certified blanking elements.

The metal housing for the Multispectrum infrared (IR) flame detector type X3301 must be electrically connected to earth ground.

For ambient temperatures below -10°C and above +60°C use field wiring suitable for both minimum and maximum ambient temperature.

Special conditions for safe use:

- The front window assembly contains a special cemented joint construction. In accordance with EN60079-1 clause 5.1.c, all inspections, repair, and/or adjustments to this front window assembly shall be done by Detector Electronics Corporation only.
- Up to two resistors may be used within the flameproof terminal compartment only.
- Each resistor may dissipate a maximum of 5 watts and must be rated appropriately for the application.
- The Multispectrum infrared (IR) flame detector type X3301 is to be installed in places where there is a low risk of mechanical damage.
- See the "Maintenance" section of this manual for guidance on minimizing the risk from electrostatic discharge.
- Flameproof joints are not intended to be repaired. See the "Device Repair and Return" section of this manual for more information on conducting repairs.

The following accessories are ATEX approved for use with the X3301 Flame Detector:

Part Number	Description
007290-001	Q9033B Stainless Steel Mounting Arm Assembly is for aluminum and stainless steel detectors
007290-002	Q9033A Aluminum Mounting Arm Assembly is for aluminum detectors only
011385-001	Q9033 Collar Attachment

APPENDIX D

IECEx APPROVAL

CERTIFICATE OF CONFORMITY

IECEx ULD 06.0017X

Ex db eb IIC T6...T5 Gb		Ex db IIC T6...T4 Gb
Ex tb IIC T130°C Db		T6 (Tamb = -55°C to +60°C)
T6 (Tamb = -50°C to +60°C)	or	T5 (Tamb = -55°C to +75°C)
T5 (Tamb = -50°C to +75°C)		T4 (Tamb = -55°C to +125°C)
IP66		IP66/IP67

Compliance with:

IEC 60079-0: 2011, Ed. 6
IEC 60079-1: 2014, Ed. 7
IEC 60079-7: 2015, Ed. 5
IEC 60079-31: 2013, Ed. 2
IEC 60529: 2013, Ed. 2.2

INSTALLATION INSTRUCTIONS

The field wiring connections in the terminal compartment are suitable certified and accepts wiring specifications from 14-24 AWG, 2.5-0.2 mm².

The Multispectrum infrared (IR) flame detector type X3301 shall be installed according to the instructions given by the manufacturer.

The cable entry devices shall be certified in type of explosion protection flameproof enclosure "d" for use with the terminal compartment in type of explosion protection flameproof enclosure "d" or in type of explosion protection increased safety "e" for use with the terminal compartment in type of explosion protection increased safety "e." They shall be IP66 rated, suitable for the conditions of use and correctly installed.

Unused entries shall be closed with suitable certified blanking elements.

The metal housing for the Multispectrum infrared (IR) flame detector type X3301 must be electrically connected to earth ground.

For ambient temperatures below -10°C and above +60°C use field wiring suitable for both minimum and maximum ambient temperature.

Special conditions for safe use:

- The front window assembly contains a special cemented joint construction. In accordance with IEC60079-1 clause 5.1.c, all inspections, repair and/or adjustments to this front window assembly shall be done by Detector Electronics Corporation only.
- Up to two resistors may be used within the flameproof terminal compartment only.
- Each resistor may dissipate a maximum of 5 watts and must be rated appropriately for the application.
- The Multispectrum infrared (IR) flame detector type X3301 is to be installed in places where there is a low risk of mechanical damage.
- See the "Maintenance" section of this manual for guidance on minimizing the risk from electrostatic discharge.
- Flameproof joints are not intended to be repaired. See the "Device Repair and Return" section of this manual for more information on conducting repairs.

The following accessories are IECEx approved for use with the X3301 Flame Detector:

Part Number	Description
007290-001	Q9033B Stainless Steel Mounting Arm Assembly is for aluminum and stainless steel detectors
007290-002	Q9033A Aluminum Mounting Arm Assembly is for aluminum detectors only
011385-001	Q9033 Collar Attachment

APPENDIX E

EN54 APPROVALS

Certification Bodies	Conventional Output		LON Output	
	Certificate/Approval Number	Basis of Approval	Certificate/Approval Number	Basis of Approval
VdS – Construction Products Regulation	0786 – CPR – 20453	EN 54-10 + A1	—	—
VdS*	G 202136	VdS 2344 VdS 2504 EN 54-10 + A1	—	—
BRE – Construction Products Regulation	—	—	0832 – CPR – F0892	EN 54-10 + A1 EN 54-17
LPCB	973e/03	EN 54-10 + A1	973a/03	EN 54-10 + A1 EN 54-17

* Approval of all sensitivities.

INSTRUCTIONS FOR THE APPLICATION OF THE APPROVAL COMPONENT/SYSTEM

The installation shall take into account, that the orientation arrow on the flame detector is directed upwards, as the view angle in this direction is <90°.

The IR-flame detector configured to medium and high sensitivity levels corresponds to class 1.

The following accessories are EN54-10, EN54-13, and EN54-17 approved for use with the X3301 Flame Detector:

Part Number	Description
102740-002	Magnet
007739-001	Magnet and Extension Pole
007290-001	Q9033B Stainless Steel Mounting Arm Assembly is for aluminum and stainless steel detectors
007290-002	Q9033A Aluminum Mounting Arm Assembly is for aluminum detectors only
011385-001	Q9033 Collar Attachment

APPENDIX F

OFFSHORE APPROVALS

USCG APPROVAL

Coast Guard Approval No. 161.002/49/0

The scope of this approval is for a fire detection system meeting 46 CFR 161.002, as part of the Eagle Quantum Premier System.

MARINE EQUIPMENT DIRECTIVE

DNV Certificate No. MED-B-9427

Is found to comply with the requirements in the following Regulations / Standards:

Annex A.1, item No. A.1/3.51 and Annex B, Module B in the Directive. SOLAS 74 as amended, Regulation II-2/7 & X/3, 2000 HSC Code 7, FSS Code 9 and IMO MSC.1/Circ. 1242.

The equipment are found to comply with following location / application dependent requirements (for definition of each of the location classes, see below the table):

MODEL	TEMPERATURE	VIBRATION	EMC	ENCLOSURE
X3301	TEM-D	VIB-B	EMC-B	ENC-C

Definition of the location classes with reference to relevant standards:

Temperature

TEM-D Location (-25°C-70°C) (ref. IEC 60092-504 (2001) table 1 item 6-7)

Vibration

VIB-D For eq. on reciprocating machines etc. (ref IEC 60092-504 (2001) table 1 item 10)

EMC

EMC-B Bridge and open deck zone (ref. IEC 60092-504 (2001) table 1 item 19-20)

Enclosure

ENC-C Open deck (IP56) (ref. IEC 60092-201 table 5)

Conformity to Module D, E and F.

TYPE APPROVAL

DNV Certificate No. TAA00000V2.

Subject Matter of the Approval

IR Flame Detector Type X3301 for use in Ships, High Speed & Light Craft, and Offshore Applications.

Application Location Classes:

Location classes for X3301 IR Flame Detector with Mounting Arm Q9033B / Q9033A and optional Q9033 Collar Attachment (Shaded areas show Det-Tronics approved location classes)

COLUMN 1		COLUMN 2				
TYPE	LOCATION WITHIN MAIN AREA	MAIN AREAS ON BOARD				
		Machinery spaces	Control room, Accommodation	Bridge	Pump room, Holds, Rooms with no heating	Open Deck
Temperature	Inside cubicles, desks, etc. with temperature rise of 5°C or more	B	B	B	D	D
	All other locations	A	A	A	C	D
Humidity	Locations where special precautions are taken to avoid condensation	A	A	A	A	A
	All other locations	B	B	B	B	B
Vibration	On machinery such as internal combustion engines, compressors, pumps, including piping on such machinery	B	—	—	B	B
	Masts	—	—	—	—	—
	All other locations	A	A	A	A	A
EMC (Electromagnetic compatibility)	All locations within specified main areas	A	A	B	A	B
	Submerged application	D	—	—	D	D
Enclosure	Below floor plates in engine room	C	—	—	—	—
	All other locations	B	A	A	B	C

The following accessories are offshore approved to the listed approvals, for use with the X3301 Flame Detector:

Part Number	Description
102740-002	Magnet
007739-001	Magnet and Extension Pole
007290-001	Q9033B Stainless Steel Mounting Arm Assembly is for aluminum and stainless steel detectors
007290-002	Q9033A Aluminum Mounting Arm Assembly is for aluminum detectors only
011385-001	Q9033 Collar Attachment

APPENDIX G

ADDITIONAL APPROVALS

SIL 2



IEC 61508

Certified SIL 2 Capable.

Applies to specific models – refer to the SIL 2 Certified X3301 Safety manual (95-8720) for details.

RUSSIA & KAZAKHSTAN



VNIIFTRI

CERTIFICATE OF CONFORMITY TO "TP TC 012/2011"

Nº TC RU C-US. BH02.B.00401

2ExdeIICT6/T5 IP66

T6 (Tamb = -50°C to +60°C)

T5 (Tamb = -50°C to +75°C)

Ex tb IIIC T130°C Db.

– OR –

1ExdIICT6/T5/T4 IP66

T6 (Tamb = -55°C to +60°C)

T5 (Tamb = -55°C to +75°C)

T4 (Tamb = -55°C to +125°C)

Ex tb IIIC T130°C Db.

RUSSIA



VNIIPO

CERTIFICATE OF CONFORMITY TO TECHNICAL REGULATIONS, GOST R 53325-2012

C-US.ПБ01.B.02910

BRAZIL



UL-BR 12.0093X

Ex db eb IIC T6...T5

Ex tb IIIC T130°C

T6 (Tamb = -50°C to +60°C)

T5 (Tamb = -50°C to +75°C)

IP66

– OR –

Ex db IIC T6...T4

T6 (Tamb = -55°C to +60°C)

T5 (Tamb = -55°C to +75°C)

T4 (Tamb = -55°C to +125°C)

IP66/IP67

CANADA

QPS



ULC/ORD-C386:2015 - Flame Detector

Flame detectors meeting these requirements must be employed in accordance with appropriate parts of the following:

- CAN/ULC-S524, the Standard for Installation of Fire Alarm Systems
- CSA-C22.1, Canadian Electrical Code, Part 1, Safety Standard for Electrical

ULC S529-09, edition: 3rd. Smoke detector for Fire Alarm System

This Standard covers relevant requirements in accordance with the following:

- In the United States: NFPA 72 (National Fire Alarm Code)
- In Canada: CAN/ULC-S524 (Installation of Fire Alarm Systems); National Building Code of Canada; and National Fire Code of Canada.

APPENDIX H

DECLARATION OF CONFORMITY

[1]



European Union



Declaration of Conformity

This declaration of conformity is issued under the sole responsibility of the manufacturer.

[2]

It is declared that the following equipment:

Model X3301 Series (Multispectrum Infrared Flame Detector)

Document reference number **DEC-1207**

[3]

Manufactured by:
 Detector Electronics Corporation (Det-Tronics)
 6901 West 110th Street
 Minneapolis, MN 55348 USA

[4]

Is in conformity with the Essential Health and Safety Requirement and the relevant Union harmonisation legislation by complying with:

ATEX Directive: 2009/94/9/EC (until April 19 th , 2016)	EN 60079-0:2012+A11:2013
2014/34/EU (from April 20 th , 2016)	EN 60079-1:2014
Certificate No.: DEMKO 01 ATEX 130204X	EN 60079-7:2007
	EN 60079-31:2014
	EN 60529:1991+A1:2000+A2:2013

EMC Directive: 2004/108/EC (until April 19 th , 2016)	EN 61000-6-1:2007
2014/30/EU (from April 20 th , 2016)	EN 61000-6-2:2005
	EN 61000-6-3:2007+A1:2011
	EN 61000-6-4:2007

Low Voltage Directive: 2006/95/EC (until April 19 th , 2016)	EN 61010-1:2010
2014/35/EU (from April 20 th , 2016)	

WEEE Directive: 2002/96/EC

Marine Equipment Directive: 96/98/EC	Annex A.1, item No. A.1/3.51 and Annex B, Module B in the directive. SOLAS 74, Regulation II-2/7 & X/3, 2000 HSC Code 7, FSS Code 9 & IMO MSC.1/Circ.1242.
Certificate No.: MED-B-9427	
Certificate No.: MED-D-1515	

Construction Products Regulation (EU) 305/2011	EN 54-10:2002+A1:2005
Certificate No.: 0786-CPR-20453 (VdS)	*EN 54-17:2005/AC:2007
*Certificate No.: 0832-CPR-F0892 (BRE)	*Applicable to EQP Model(s) Only

[5]

Production QAN Issued by:
 UL International DEMKO A/S, NB, No. 0539
 Borupvang 5A, 2750 Ballerup, Denmark

[6]

The Marking of the equipment or protective system shall include the following:

	II 2 G Ex db eB IIC T6...T5 IP66
	II 2 G Ex db IIC T6...T4 IP66/IP67
	II 2 D Ex tb IIIC T130°C IP66

CONTACT THE FACTORY FOR OFFICIAL COPY



95-8704



FlexSonic® Acoustic
Leak Detector



X3301 Multispectrum
IR Flame Detector



PointWatch Eclipse® IR
Combustible Gas Detector



FlexVu® Universal Display
with GT3000 Toxic Gas Detector



Eagle Quantum Premier®
Safety System

Specifications subject to change without notice.

All trademarks are the property of their respective owners.

© 2020 Carrier. All Rights Reserved.



Corporate Office
6901 West 110th Street
Minneapolis, MN 55438 USA
www.det-tronics.com

Phone: +1 952.941.5665
Toll-free: +1 800.765.3473
Fax: 952.829.8750
det-tronics@carrier.com