

Eagle Quantum Premier®

8 Channel Analog Input Module (AIM)

Model EQ3710AIM

DESCRIPTION

The EQ3710AIM 8 Channel Analog Input Module expands the input capability of the Det-Tronics Eagle Quantum Premier® System.

The unit provides a means of connecting devices with a calibrated 4-20 mA output signal to the Eagle Quantum Premier System.

For fire detector 4-20 mA inputs, the Analog Input Module (AIM) is FM Approved for NFPA 72 initiating device circuit.

For gas detector 4-20 mA inputs, the AIM provides 8 configurable channels that can be set for either combustible gas or universal mode. The combustible gas mode provides a number of automatically programmed settings, and alarm thresholds that are limited to approval body requirements. The universal mode is used for generic devices where control over all configuration parameters is required. All devices must provide their own calibration facilities.

System status can be determined using the troubleshooting procedures, Det-Tronics Safety System Software (S³), and the status indicators on the module.

The Analog Input Module can be mounted directly to a panel, or it can be DIN rail mounted utilizing the DIN rail adapter.

THEORY OF OPERATION

The EQ3710AIM allows input of up to eight 4-20 mA devices. Each channel is fully configurable to provide device and alarm information. This information includes tag name, descriptor, engineering units, fault alarm, Low/High alarm, and alarm threshold limits.

Each channel has individual status indication and inhibit control. This feature inhibits the low and high alarms, thus allowing maintenance procedures to be performed.

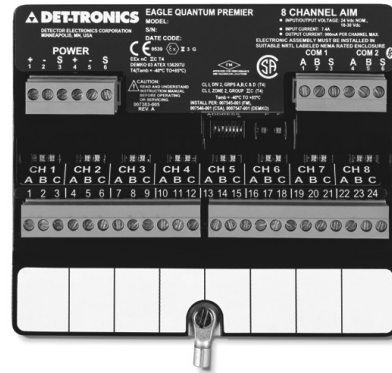

LED INDICATORS

LEDs on the front panel of the module are provided for indicating device status conditions. The LED's are tested upon power-up to verify their operation. Red LEDs indicate an active alarm condition (blinking red indicates a low alarm is active and a steady red indicates a high alarm is active). Yellow LEDs indicate a trouble condition (blinking yellow indicates a low power or unconfigured condition, and steady yellow indicates that an out of range low or high fault is present).

MOUNTING

The Analog Input Module is DIN rail or direct panel mountable for configurations requiring installation in NEMA or IP enclosures. DIN rail and mounting clip options must be specified at the time of order. Refer to the "Specifications" section for mounting arrangements and dimensions.

ACCESSORIES

An optional HART interface module is available for use with HART compatible transmitters. The interface module allows HART information to be accessed by a HART communicator from the interface module location.

FEATURES

- Expands the capabilities of the Det-Tronics Eagle Quantum Premier® system
- Monitors eight independent analog channels
- Individual channels are configurable as combustible gas sensor or universal sensor
- Individual channels can be inhibited
- Individual channel LEDs indicate Active and Fault status
- Provides remote input capabilities via LON/SLC
- Panel or DIN rail mounting
- Power LED display
- Plug-in wiring connectors
- RFI and EMI hardened (CE Marked)
- FM/CSA/ATEX/CE/IECEx approved
- SIL model available

SPECIFICATIONS

POWER REQUIREMENTS—

Module power consumption: 6 watts.
 When supplying power to three-wire transmitters:
 Maximum current at power input: 7.4 amperes.
 Output current: 900 mA per channel maximum.

INPUT/OUTPUT VOLTAGE—

24 vdc nominal, 18 to 30 vdc. 10% overvoltage will not cause damage to the equipment.

TEMPERATURE RANGE—

Operating: -40°C to $+85^{\circ}\text{C}$ (-40°F to $+185^{\circ}\text{F}$).
 Storage: -55°C to $+85^{\circ}\text{C}$ (-67°F to $+185^{\circ}\text{F}$).

HUMIDITY RANGE—

0 to 95% RH, non-condensing.

VIBRATION—

FM 3260-2000 (clause 4.9).

CHANNEL ACCURACY—

Zero: $\pm 0.3\%$ full scale from -40°C to $+85^{\circ}\text{C}$ (-40°F to $+185^{\circ}\text{F}$).
 Span: $\pm 0.5\%$ full scale from -40°C to $+85^{\circ}\text{C}$ (-40°F to $+185^{\circ}$).

RESPONSE TIME—

1 to 100 LON devices: < 2 seconds
 101 to 200 LON devices: < 3 seconds
 201 to 246 LON devices: < 4 seconds.

LON COMMUNICATION—

Digital communication, transformer isolated (78.5 kbps).

DIMENSIONS—

Refer to Figure 1.

SHIPPING WEIGHT—

1 lbs. (0.45 kg).

CERTIFICATION—

FM/CSA Class I, Div. 2, Groups A, B, C, D (T4).
 Class I, Zone 2, Group IIC (T4).



ATEX/CE: ATEX/EMC Directive Compliant.



CE 0539 II 3 G
 Ex nA nL nC IIC Gc EN60079-29-1
 DEMKO 03 ATEX 136207U
 Tamb = -40°C to $+85^{\circ}\text{C}$.

IECEx:



IECEx ULD 10.0004U.
 Ex nA nL nC IIC Gc.
 Tamb = -40°C to $+85^{\circ}\text{C}$.

SIL:



IEC 61508:2000
 Certified SIL 2 Capable.
 Applies to specific models –
 Refer to the SIL 2 Certified
 EQP Safety manual (95-8599).

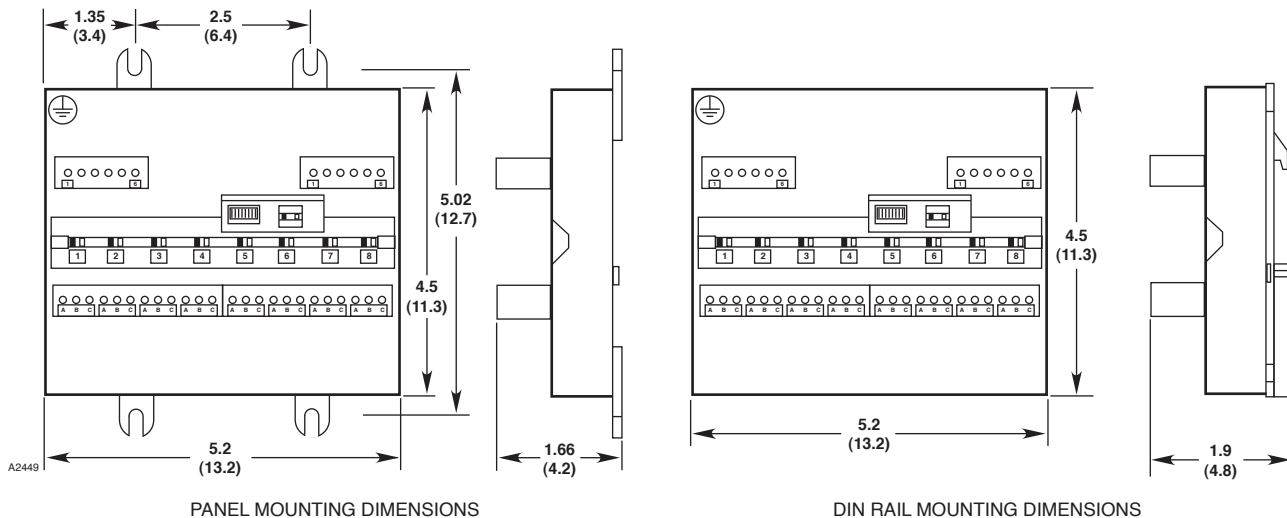

Figure 1—Dimensions of the Analog Input Module in Inches (Centimeters)

INSTALLATION

MOUNTING

The Analog Input Module must be properly installed in a suitable enclosure that is rated for the location. The enclosure must provide space to install and wire the device and must also provide for ground wire termination. Access into the enclosure must be gained by using a special tool to open the enclosure. The enclosure should be rated for the temperature range of the location plus the temperature rise of all equipment installed inside the enclosure. The enclosure must be rated for electrical equipment that is going to be installed.

NOTE

It is recommended to maintain a minimum of 4 inches clearance between the module and other equipment to provide adequate room for wiring and ventilation.

WIRING

All electrical connections are made to the field wiring connectors furnished with the module. (Connectors accept up to 12 AWG wire.) Refer to Figure 2 for identification of module wiring terminals.

Power Connector — Terminals 1 to 6 24 Vdc Power Input

- 1 — + } 24 VDC
- 2 — - }
- 3 — SHLD*
- 4 — + } 24 VDC
- 5 — - }
- 6 — SHLD*

*Shields on power wires are optional unless required by local codes.

Connect the module power supply to terminals 1 and 2. If additional terminals are required for powering other devices, these devices should be connected to terminals 4 and 5. Shields are to be connected to terminals 3 and 6.

COM Connector — Terminals 1 to 6 LON Terminals

Be sure to observe polarity when wiring the LON.

- 1 — "A" side of signaling circuit for COM 1
- 2 — "B" side of signaling circuit for COM 1
- 4 — "A" side of signaling circuit for COM 2
- 5 — "B" side of signaling circuit for COM 2
- 3 & 6 — shield connections (shields required).

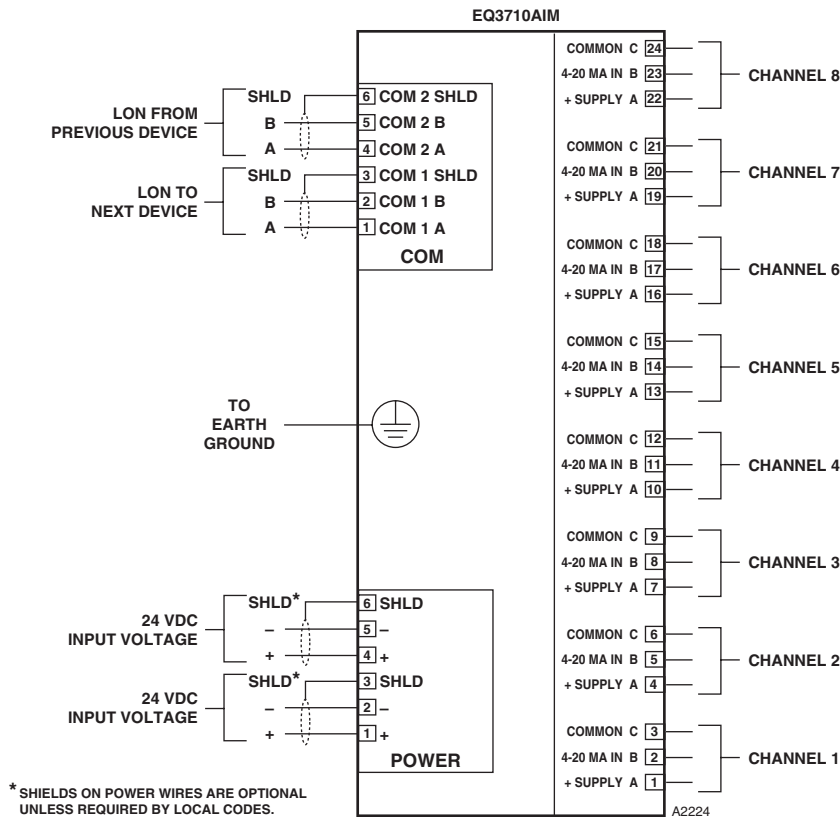

Figure 2—Analog Input Module Wiring Terminal Configuration

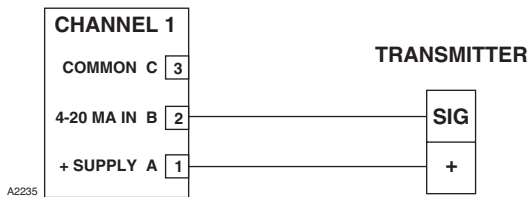

Figure 3—Two-Wire Transmitter / Detector — Non-Isolated 4 to 20 mA Current Output (Sourcing)

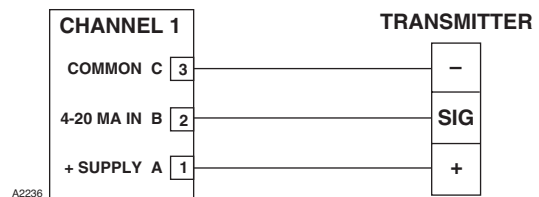

Figure 5—Three-Wire Transmitter / Detector — Non-Isolated 4 to 20 mA Current Output (Sourcing)

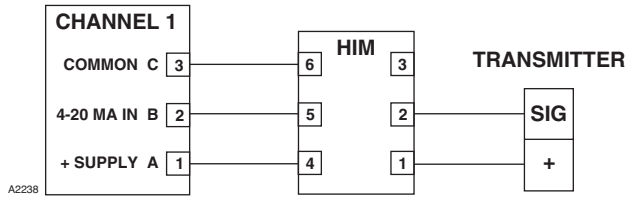

Figure 4—Two-Wire Transmitter / Detector with HART Interface Module — Non-Isolated 4 to 20 mA Current Output (Sourcing)

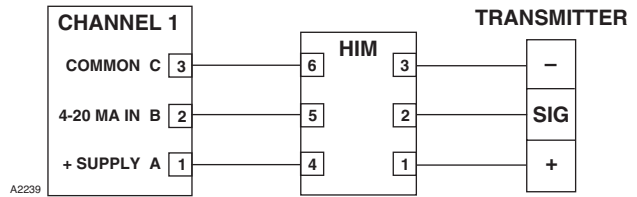

Figure 6—Three-Wire Transmitter / Detector with HART Interface Module — Non-Isolated 4 to 20 mA Current Output (Sourcing)

**Channel Connectors — Terminals 1 to 24
4-20 mA Input Devices**

Connect external wiring to the appropriate terminals on the analog input module terminal block. See Figure 3 for an example of a 2-wire input. See Figure 4 for a 2-wire input with HART interface module. See Figure 5 for a 3-wire input, where the transmitter must source a 4-20 mA signal. See Figure 6 for a 3-wire input with HART interface module.

Only channel 1 is shown in each diagram. The information is typical for channels 2-8.

**Analog Input Module Channels used as NFPA 72 Approved
4-20 mA Flame Detector Input**

Configure the High Alarm setpoint at 19 mA via the S³ configuration screen, and use the High Alarm to trigger the Fire Alarm in S³ logic. The AIM sends an exception message for the High Alarm so there is no delay in transmitting the Fire Alarm.

Fault indications and other status information must be decoded in logic from the analog process variable. A five second delay should be used to avoid indicating an incorrect status condition while the analog value is changing between two values. See Table 1.

Table 1—Analog Values (in mA) for Fault and Status Indications when the AIM is Used as a 4-20 mA Flame Detector Input

Status	X3301/2	X5200	X9800	X2200
Fault	0 to 3.5	0 to 3.5	0 to 3.5	0 to 3.5
IR Pre-Alarm		7.0 to 9.0		
UV Alarm		11.0 to 12.99		
IR Alarm		13.0 to 14.99		
Pre-Alarm		15.0 to 16.99	15.0 to 16.99	15.0 to 16.99

CONFIGURATION

Setting Analog Input Module Network Address

One unique network address must be assigned to each analog input module. The address is set by the 8 switch DIP assembly on the module. The address is binary coded and is the sum of all switches placed in the “closed” position.

Each discrete point of an analog input module has a tag number and a descriptor for unique identification.

Det-Tronics S³ Safety System Software is used for device configuration. The following tables show the minimum software/firmware releases:

For Gas Applications

Controller Firmware*		AIM		S3
Rev.	Version	Rev.	Version	Version
B	3.06	B	1.02	2.9.1.1

*for part number 007606-002

For Flame Applications

Controller Firmware*		AIM		S3
Rev.	Version	Rev.	Version	Version
C	5.52	D	1.07	4.0.0.0

*for part number 008983-001

ORDERING INFORMATION

When ordering, please specify:

EQ3710AIM 8 Channel Analog Input Module



Specifications subject to change without notice.

All trademarks are the property of their respective owners.
© 2020 Detector Electronics Corporation. All rights reserved.

Det-Tronics manufacturing system is certified to ISO 9001—the world’s most recognized quality management standard.

Corporate Office
6901 West 110th Street
Minneapolis, MN 55438 USA
www.det-tronics.com

Phone: +1 952.941.6665
Toll-free: +1 800.765.3473
Fax: 952.829.8750
det-tronics@carrier.com