

Eagle Quantum Premier® (EQP) Addressable Smoke Module (ASM) Model EQ3760ASM

DESCRIPTION

The Eagle Quantum Premier® (EQP) Addressable Smoke Module (ASM) is designed to expand the input and output capability of Detector Electronics Corporation's (Det-Tronics®) EQP System.

The ASM is a certified SIL2 capable interface device designed to provide continuous and automated fire protection. It ensures system operation through supervision of system inputs/outputs and Local Operating Network/Signaling Line Circuit (LON/SLC) monitoring in the controller.

The ASM is located directly on the LON of the EQP system, with a loop of up to 100 addressable devices connected to the ASM. This allows the EQP controller to annunciate a fire alarm from either its own LON based I/O or from the ASM connected addressable detection loops.

System status can be determined using the Eagle Quantum Safety System Software (S³ Version: 10.15.0.5 or later), and the status indicators on the module.

FEATURES AND BENEFITS

- Expands the capabilities of Det-Tronics' Eagle Quantum Premier system
- EQP Controller can support up to 10 ASM Modules on a loop

NOTE

This support is dependant on system configuration and logic within S³.

- Provides power and communications to 100 addressable devices
- Utilizes Apollo Discovery devices
- XP95 protocol/devices supported

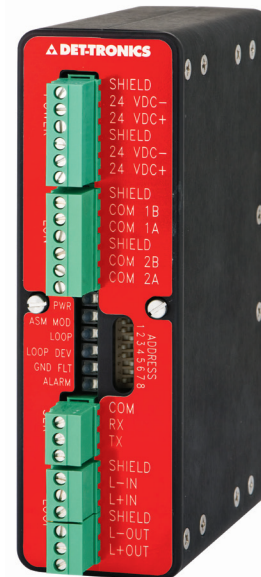

- ASM Module alarm and fault conditions are logged in the EQP Controller
- LEDs for easy annunciation of power, faults and active devices on the loop
- Monitors single addressable devices
- Provides remote I/O capabilities via LON/SLC
- DIN rail or panel mounting
- Plug-in wiring connectors
- RFI and EMI hardened
- Approved for use in marine applications (Panel mount only)
- SIL2 when using SIL rated smoke detectors
- Provides intrinsic safety smoke detector option

THEORY OF OPERATION

During normal operation, the ASM Module continuously monitors the loop for alarm and fault conditions and executes user defined programmed logic that coordinates the control of the field devices. The ASM Module reports any device based fault and alarm conditions to the EQP Controller.

The ASM Module can support different Apollo Discovery and XP95 devices (see Table 3). The supported devices include smoke detectors, heat detectors, manual calls, sounders, beacons and I/O modules. The addressable devices are configured individually via the ASM Apollo Editor in the S³ software.

To ensure reliable system operation, the ASM Module can continuously monitor its input and output circuits for open and short circuit conditions. The EQP Controller also continuously monitors the status of the ASM Module as well as the status of each device connected to the ASM Module.

The controller communicates with the ASM Module by continuously broadcasting a heartbeat signal over the LON (Figure 1). This heartbeat is used for verifying the integrity of the LON and for keeping the addressed field devices from going into a fault isolation mode. For detailed information on the EQP Controller, refer to instruction manual 95-8533.

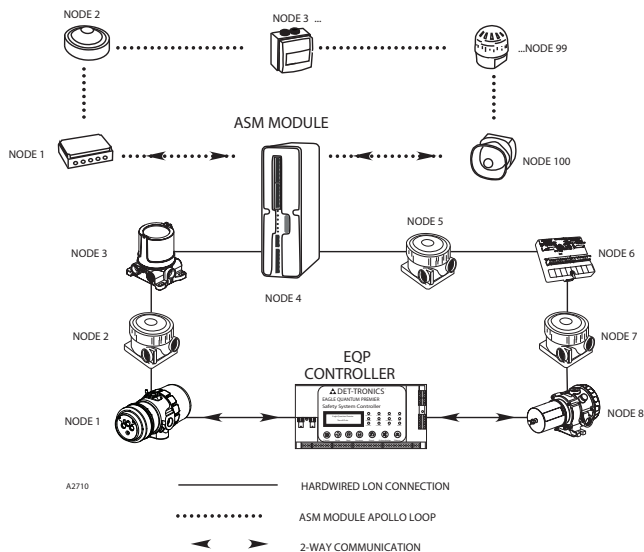

Figure 1—EQP LON with ASM Module Communication

ISOLATORS

Isolators are used to disconnect a shorted section of the ASM Module Apollo loop so that the remaining sections can continue to operate. In accordance with the NFPA 72 standard for SLCs, the ASM Module supports Class A, Class B, and Class X SLC wiring styles.

NOTE

A maximum of 101 isolators may be used on the Apollo loop.

For the Class A wiring style, isolators are optional on the ASM Module Apollo loop where only a single zone is monitored. During a single open, a single ground fault, or the combination of a single open and a single ground fault, the Class A pathway shall maintain alarm receipt capabilities. See Figure 2 for Class A pathway.

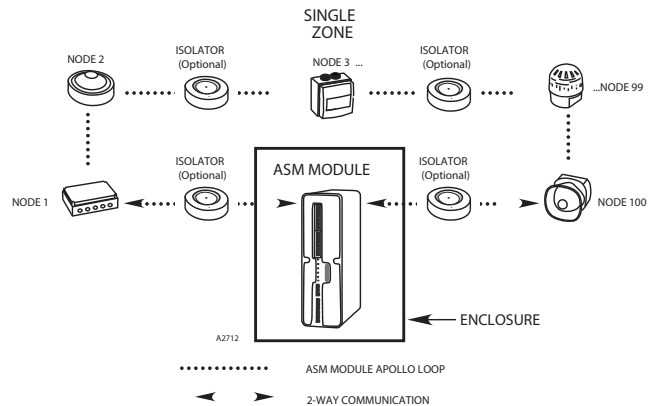

Figure 2—Class A Pathway (isolators are optional)

Class B requires that a spur configuration be used, with the single spur connected to the “Loop Out” terminals on the ASM Module. The Class B pathway is intended for use in a single zone system. When a single ground fault is present, alarm receipt capabilities shall be maintained. Devices beyond a single open will lose connection, but all devices will lose connection for a short. See Figure 3 for Class B pathway.

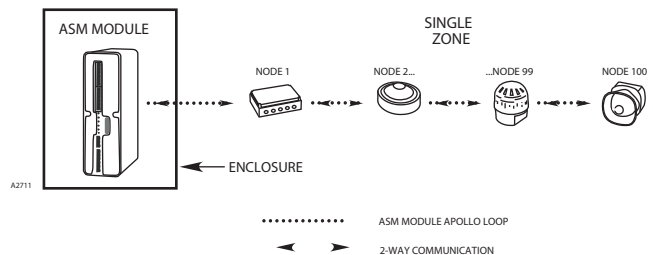

Figure 3—Class B Pathway (without isolators)

Class X is intended for use in a multi-zone system and requires that the first isolator on each leg be installed next to the ASM Module, within the same enclosure. In addition, an isolator is needed between each zone as illustrated in Figure 4. Alarm receipt capabilities in the other zones shall be maintained during a single open, single ground, wire-to-wire short, or open and ground.

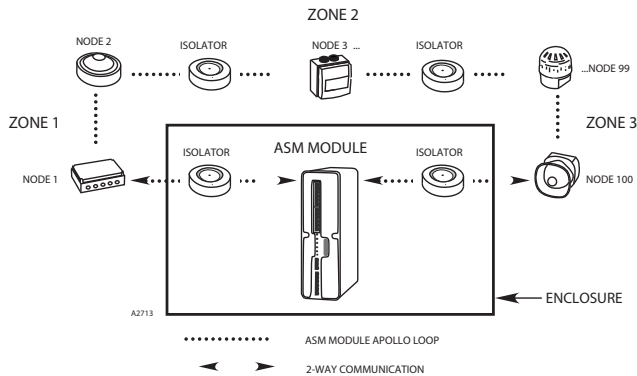

Figure 4—Class X Pathway (multi-zone with isolators)

NOTE

The isolator has an operating temperature range of +32°F to +100°F (0°C to +38°C). This means that, for Class X installations, the enclosure temperature will be rated to +100°F (+38°C) max.

Reference Table 1 for further details on the performance requirements for SCLs as defined by NFPA 72.

LED INDICATORS

LEDs on the front of the ASM Module are provided for indicating device status conditions. There are 6 LED status indicators (Power, ASM Module Fault, Loop Fault, Loop Device Fault, Ground Fault, and Alarm) located on the front panel (Figure 5). Refer to Table 2 for a description of the LED indicators.

MOUNTING

The ASM Module can be DIN Rail or Panel mounted.

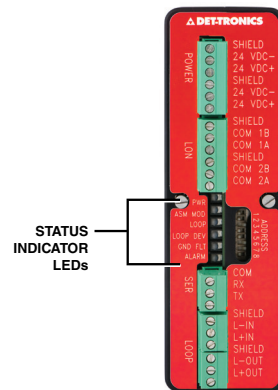

Figure 5—Location of LED Indicators

Table 2—ASM Module Device Status Indicators

LED	Label	ASM Module Status*
Green	PWR	On when power is present
Yellow	ASM MOD	Fault in the ASM Module
Yellow	LOOP	Loop Fault
Yellow	LOOP DEV	Fault with a device on the loop
Yellow	GND FLT	Ground fault on the Apollo loop
Red	ALARM	An alarm is present

*Reference to “loop” refers to the ASM Module or Apollo device loops.

ADDRESSABLE LOOP DEVICES

See Table 3 for a list of all supported Apollo loop devices.

NOTE

The input and/or output circuits for the Mini Monitor Module and Priority Mini Switch Monitor (P/N 55000-765), Priority Switch Monitor (P/N 55000-806), Input / Output Module (P/N 55000-820) and Sound Control Module (P/N 55000-825) must be no longer than 20 ft (6 m) and must be installed in conduit or equivalently protected against mechanical injury.*

For additional information and documentation regarding all Apollo devices, visit www.apollo-fire.co.uk.

Table 1—Performance of Signal Line Circuits (SLCs)

NFPA 72-2013 Class	Class B			Class A			Class X		
	Alarm	Trouble	ARC	Alarm	Trouble	ARC	Alarm	Trouble	ARC
Condition	1	2	3	4	5	6	7	8	9
Single open	–	X	–	–	X	R	–	X	R
Single ground	–	X	R	–	X	R	–	X	R
Wire-to-wire short	–	X	–	–	X	–	–	X	R
Open and ground	–	X	–	–	X	R	–	X	R

ARC = Alarm Receipt Capability
R = Required capability
X = Indication required at protected premises

Table 3— List of supported devices

DET-TRONICS PART NUMBER	APOLLO PART NUMBER	DEVICE NAME
000515-503	5800-400	Apollo Heat Detector, EU
000515-XXX	58000-400MAR	Apollo Heat Detector, EU Marine
000515-XXX	55000-440	Apollo Heat, IS **
000515-XXX	58000-400SIL	Apollo Heat Detector, SIL2
000515-553	58000-450	Apollo Heat Detector, FM
000515-501	58000-500	Apollo Ionization Smoke, EU
000515-XXX	58000-500MAR	Apollo Ionization Smoke, Marine
000515-XXX	58000-600MAR	Apollo Smoke, EU Marine Optical
000515-XXX	58000-600SIL	Apollo Smoke, SIL2 Optical
000515-XXX	58000-540	Apollo Ionization Smoke, IS **
000515-XXX	58000-640	Apollo Smoke, IS Optical **
000515-551	58000-550	Apollo Ionization Smoke, FM
000515-552	58000-650	Apollo Optical Smoke Detector, FM
000515-550	53546-022	Apollo Duct Smoke Det. Base EU
000515-XXX	58000-700MAR	Apollo Multisensor, EU Marine
000515-504	58000-700	Apollo Multisensor, EU
000515-XXX	58000-700SIL	Apollo Multisensor, SIL2
000515-554	58000-750	Apollo Multisensor, FM
000515-505	58000-300	Apollo Carbon Monoxide Detector, EU
000515-509	55000-847	Apollo Input / Output Unit, with Isolator
000515-512	58100-908	Apollo Manual Call, with Isolator
000515-513	58100-951	Apollo Manual Call, with Isolator, IP66
000515-517	55000-877	Apollo Beacon, Red
000515-557	55000-750	Apollo Isolator, FM
000515-559	55000-806	Apollo XP95A Priority Switch Monitor, FM
000515-560	55000-825	Apollo XP95A Sounder Control Module, FM
000515-561	55000-820	Apollo XP95A Input / Output Module, FM
000515-XXX	45681-210MAR	Apollo Mounting Base, Marine, FM
000515-XXX	45681-215	Apollo Mounting Base, IS
000515-XXX	45681-211MAR	Apollo Isolator Base, Marine, FM
000515-XXX	45681-242	Apollo Relay Base, FM, EU
000515-XXX	45681-211	Apollo Isolator Base, FM
000515-XXX	55100-940	Apollo Manual Call Point, Standard, Non-Isolated, Waterproof, IS **
000515-XXX	55000-960	Apollo Manual Call Point, Break Glass, Non-Isolated, Waterproof IS **
000515-XXX	55000-970	Apollo Manual Call Point, Push Button, Non-Isolated, Waterproof, IS **
000515-XXX	55200-910	Apollo Manual Call, Standard, Non-Isolated, Non-Waterproof, EU
000515-XXX	55200-950	Apollo Manual Call, Standard, Non-Isolated, Waterproof, EU
000515-XXX	58200-971MAR	Apollo Manual Call, Standard, Isolated, Waterproof, Marine
000515-XXX	58100-908SIL	Apollo Manual Call, Standard, Isolated, Non-Waterproof, SIL2
000116-180	53832-070	Apollo Remote Led 1 Gang Red
000515-510	55000-852	Apollo Sounder Control Unit
000515-515	55000-278	Apollo Sounder, 100dB, Red
000515-518	55000-293	Apollo Sounder / Beacon, with Isolator
000515-516	55000-274	Apollo Sounder, 100dB, Red, IP66
000515-XXX	55000-041	Apollo Sounder XP95a, Isolated, Non-Weatherproof, UL
000515-XXX	58000-005	Apollo Sounder Beacon Discovery, Non-Isolated, Non-Weatherproof, EU
000515-XXX	55000-298	Apollo Sounder Beacon XP95, Isolated, Waterproof, EU
000515-XXX	55000-374MAR	Apollo Sounder Beacon Discovery, Non-Isolated, Weatherproof, Marine
000515-XXX	58000-011	Apollo Sounder Beacon Discovery, Non-Isolated, Weatherproof, UL
000515-XXX	55000-398MAR	Apollo Sounder Beacon Discovery, Isolated, Weatherproof, Marine
000515-XXX	55000-182	Apollo Sounder Control, Din Rail, EU
000515-XXX	55000-181MAR	Apollo Sounder Control, Din Rail, Marine
000515-XXX	55000-803	Apollo I/O, Din Rail, EU
000515-XXX	55000-774MAR	Apollo I/O, Din Rail, Marine
000515-XXX	55000-588	Apollo 3 Channel I/O, Standard, EU
000515-XXX	55000-847SIL	Apollo I/O, Standard, SIL2
000515-XXX	55000-804	Apollo Relay Output, Din Rail, EU
000515-XXX	55000-771MAR	Apollo Relay Output, Din Rail, Marine
000515-511	55000-841	Apollo Switch Monitor Plus
000515-XXX	55000-822	Apollo Switch Monitor, Din Rail, EU
000515-XXX	55000-772MAR	Apollo Switch Monitor Plus, Din Rail, Marine
000515-XXX	55000-775MAR	Apollo Mini Switch Monitor, Mini, Marine
000515-XXX	55000-845	Apollo Zone Monitor, Standard, EU
000515-XXX	55000-812	Apollo Zone Monitor, Din Rail, Eu
000515-XXX	55000-773MAR	Apollo Zone Monitor, Din Rail, Marine
000515-XXX	55000-859	Apollo Vac I/O, Standard
000515-XXX	55000-855	Apollo Is Protocol Translator, Sgl **
000515-XXX	55000-856	Apollo Is Protocol Translator, Dbl **
000515-XXX	29600-098	Apollo Is Galvanic Barrier **
000515-XXX	55000-721MAR	Apollo Isolator, Marine
000515-562	55000-765*	Apollo Mini Monitor Module, NA or Apollo Priority Mini Switch Monitor, FM

The device type depends on the priority switch setting on the device.

** Not FM approved as non-interfering

FM = FM Approved

EU = European Approvals

Table 4— Apollo and Det-Tronics Part Numbers ending in DET have Det-Tronics Labels with only UL Approval

UL BASIC FILE NO.	DET-TRONICS PART NUMBER	APOLLO PART NUMBER	DEVICE NAME
S5022	000515-507DET	45681-284DET	Isolating Base, FM
S24867	000515-605DET	56000-005DET	Pull Station, Addressable, Dual, UL Listed
S5022	000515-552DET	58000-650DET	Optical Smoke Detector, FM
S5053	000515-553DET	58000-450DET	Heat Detector, FM
S5022	000515-554DET	58000-750DET	Multisensor Smoke Detector, FM
S5022	000515-555DET	45681-210DET	Mounting Base, 4", FM
S5022	000515-556DET	45681-225DET	Mounting Base, 6", FM
S7003	000515-557DET	55000-750DET	Isolator, FM
S7003	000515-558DET	45681-211DET	Isolator Base, FM
S7003	000515-559DET	55000-806DET	Priority Switch Monitor, FM
S7003	000515-560DET	55000-825DET	Sounder Control Mod, FM
S7003	000515-561DET	55000-820DET	I/O Module, FM
S7003	000515-562DET	55000-765DET	Mini Monitor Module, FM
S7003	000515-620DET	55000-863DET	Relay Output Module, FM
	000515-557	55000-750	Isolator Module, FM

The device type depends on the priority switch setting on the device.

** Not FM approved as non-interfering

FM = FM Approved

EU = European Approvals

POWER-UP SEQUENCE

Set the ASM Module network address prior to applying power. Make sure all the necessary connections are made between the ASM Module and the Controller. At power-up the "PWR" (Power) LED will illuminate and remain steady. Allow at least 15 seconds between power cycles for proper ASM loop initialization.

FAULTS

When a fault condition occurs, a yellow LED on the front panel of the ASM Module will become active. There are 4 yellow LEDs for different categories of faults.

Module faults

A module fault occurs when a fault is detected within the ASM Module, such as:

- Low voltage fault
- Memory fault
- Crystal oscillator fault
- Battery fault

Loop faults

A loop fault is related to the Apollo device's loop communication and configuration, such as:

- Open loop
- Shorted loop
- Device missing
- Extra device
- Wrong device
- Multiple devices

Loop device faults

A loop device fault is related to an individual device on the loop, and is typically fixed by replacing the faulty device. Any of the following faults can be categorized as a loop device fault:

- Integrity check fault
- Device open
- Device short
- Device hardware faults
- Drift warning
- Earth fault

Ground faults

Ground faults occur when a short or partial short exists between the loop wiring and earth on the Apollo loop. There is a local dedicated LED indicator that activates when there is either a positive or negative ground fault.

CONTROL MESSAGE

The control message manages loop device specific commands, such as integrity check, LED, relay and sound control. The control message is transmitted from the controller every 20 seconds, or immediately when there is a change in the state of an output channel. A fault will be annunciated if the control message is not received at the controller within 2 minutes.

INTEGRITY CHECK

Integrity checks are internal tests that are performed on loop devices that support the integrity check feature. All Apollo Discovery detectors and manual call points are equipped with the integrity check feature. The integrity check may be initiated and monitored via the ASM Module point display in S3.

Passive and Active Integrity Checks

During a passive integrity check no alerts will be sent to the ASM Module or EQP Controller. All indications will be handled by the local LEDs on the loop devices.

An active integrity check will be indicated on the ASM Module, the controller, and the loop devices as an active alarm. A fault indication will be generated if the integrity check fails.

Automatic Integrity Check (AIC)

When enabled, an automatic integrity check is performed every 24 hours for all the loop devices. The ASM Module controls the initiating of the integrity check for each loop device, one at a time. The AIC is disabled by default and the start time is configurable within the ASM Apollo editor in S³. If a device is currently in the middle of an AIC, and the AIC becomes disabled, that particular device will conclude its test, but no new test will begin. Manual integrity check requests are ignored during an AIC, and if a manual integrity check is in progress when an AIC is scheduled, the AIC will be delayed.

Manual Integrity Check (MIC)

The manual integrity check can be performed individually for a single loop device, or globally for all devices on a single ASM Module.

NOTE

If a manual integrity check is already in progress, a new request of either an AIC or MIC will be ignored.

Integrity Check Faults

When an integrity check fails, the loop device fault LED will be activated. The fault indication will remain until an ASM Module reset is performed, or until another integrity check is done, and passes.

NOTE

If there is an active alarm, any new integrity check request is ignored. If an integrity check is in progress and an alarm condition occurs, the integrity check will be interrupted and the alarm will be annunciated.

WALK TEST

The walk test is intended to verify the operation of the loop devices. A walk test is activated by physically walking up to each device, one at a time, and setting them into an alarm condition. Alternatively, a walk test can be activated from the ASM Module's point display within S³. The test verifies that each device does indeed go into an alarm. The alarm condition is logged into the EQP Controller, but the controller takes no further action.

SPECIFICATIONS

INPUT VOLTAGE—

24 Vdc nominal, 18 to 30 Vdc.

INPUT CURRENT (Maximum)—

690 mA.

LOOP CURRENT (Maximum)—

225 mA.

POWER CONSUMPTION (Maximum)—

11 Watts.

WIRING (Maximum)—

	12 AWG	14 AWG	16 AWG
	4 mm ²	2.5 mm ²	1.5 mm ²
Feet	15500	9800	5000
Meters	4700	3000	1500

TEMPERATURE RANGE—

Operating: -40°F to +185°F (-40°C to +85°C).

Storage: -67°F to +185°F (-55°C to +85°C).

HUMIDITY RANGE—

5 to 95% RH, non-condensing.

DIMENSIONS—

See Figure 6.

SHIPPING WEIGHT—

2.7 pounds (1.22 kilograms)

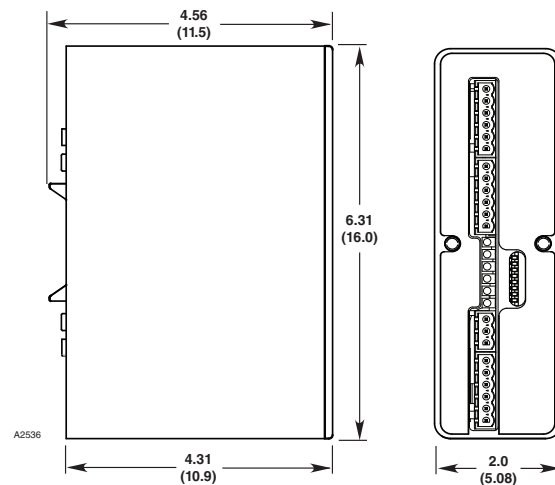

Figure 6—Dimensions of the ASM Module in Inches (Centimeters)

CERTIFICATION —

FM / CSA: Class I, Div. 2, Groups A, B, C, D (T4)
 Class I, Zone 2, Group IIC (T4)
 Tamb = -40°C to +85°C



Electronic assembly must be installed in a suitable locked NRTL labeled NEMA rated enclosure.

ATEX: Ex II 3 G
 Ex nA nC IIC T4 Gc
 DEMKO 10 ATEX 150744X
 Tamb = -40°C to +85°C



Compliance with: EN 60079-0:2012
 EN 60079-15:2010



Special conditions for safe use:

The EQ3760ASM shall be used in an area of no more than pollution degree 2 per IEC 60664-1, and in an enclosure with a tool removal cover that complies with all relevant requirements of EN 60079-15, rated at least IP54, and be connected to supply circuits where the rated voltage cannot be exceeded by 40% caused by transient disturbances.

The EQ3760ASM may only be installed, connected or removed when the area is known to be non-hazardous. The maximum surface temperature inside the EQ3760ASM does not exceed 130°C.

Transient protection shall be provided that is set at a level not exceeding 140% of the peak rated voltage value at the supply terminals to the equipment.

Installation instructions:

For ambient temperatures below -10°C and above +60°C, use field wiring suitable for both minimum and maximum ambient temperatures.

The screw terminals are to be tightened with a minimum torque of 0.5 Nm.



IECEx UL 20.0112X
 Ex nA nC IIC T4 Gc
 Tamb = -40°C to +85°C.

Compliance with: IEC 60079-0:2017 (Ed. 7)
 IEC 60079-15:2017 (Ed. 5)

The ASM Module can **not** be used for applications that fall within the scope of the CPR directive.

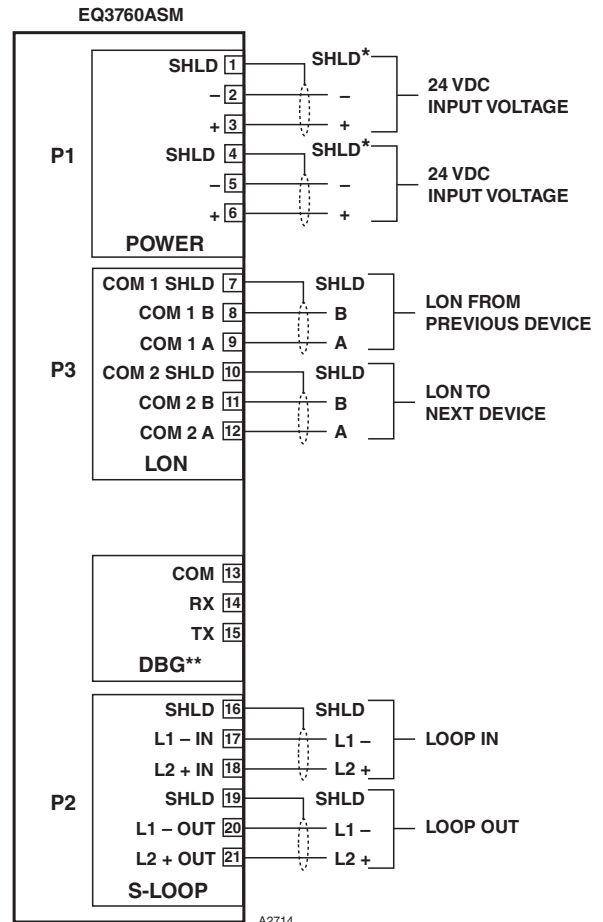

* SHIELDS ON POWER WIRES ARE OPTIONAL UNLESS REQUIRED BY LOCAL CODES.

** FOR FIELD SERVICE USE ONLY.

Figure 7—ASM Module Wiring Terminals

INSTALLATION

All electrical connections are made to the field wiring connectors furnished with the module. Refer to Figure 7 for identification of module wiring terminals.

CONFIGURATION

SETTING ASM MODULE NETWORK ADDRESS

One unique network address must be assigned to the ASM Module. The address is set by the 8 switch DIP assembly on the module (see Figure 8). The address is binary coded and is equal to the added value of all closed switches.

Det-Tronics' S³ Safety System Software is used for device configuration. For complete configuration details, please refer to the S³ User's Guide (95-8560).

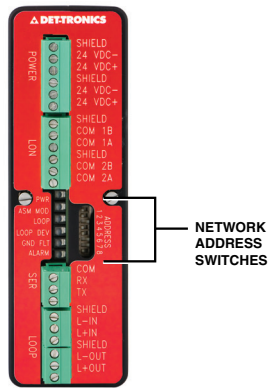

Figure 8—Location of Network Address Switches

APOLLO DEVICES

Apollo Discovery detectors and manual call points have the following specific configurable parameters that must be set within the Apollo Editor in S³:

Loop Device Type

All the Apollo loop devices supported by the ASM Module are listed. Once a device has been chosen from the list, different parameters must be configured based on the selected device.

Group Address (Sounders)

Sounders and sounder control units may be configured to operate in a group mode. All the sounders in a particular group will activate simultaneously, whether continuous or pulsed. For synchronized evacuation signalling, approved signalling devices must be connected.

Time Delay

A time delay between 0 and 30 seconds may be configured for the time an Apollo device must be continuously in alarm before the controller annunciates the condition. The alarm must be present for the entire delay time.

Day/Night Mode

The day/night mode is an option to allow the response mode (sensitivity) of Apollo detectors to be automatically adjusted to 1 of 2 values throughout a 24-hour period (this mode applies to loop device detectors only). This feature is useful for adjusting detector sensitivity where occasional time specific interference may occur.

Day Mode Start / Stop time

The day/night mode is enabled simply by setting the day response mode to a different value than the night response mode. The start and stop times are then set according to the desired switchover time. At the start time, the response mode is set to the “Day Mode Start Time” setting. At the stop time, the response mode is set to the “Day Mode Stop Time” setting.

If the day response mode value is set equal to the night response mode, the day/night mode functionality is effectively disabled. The default value for the start time is 8:00 AM, and 10:00 PM for the stop time. The start and stop times are processed in 15 minute increments.

Response modes (Sensitivity)

All Discovery detectors have a sensitivity parameter that may be set to 1 of 5 different levels. The most sensitive level is 1, and the least sensitive level is 5. The default value for both the day response mode and the night response mode is 3. See the table below for all the sensitivity levels.

Mode	Sensitivity
1	Very High
2	High
3	Medium (Default)
4	Low
5	Very Low

Flashing led mode

The flashing LED mode is a configuration parameter that is part of Apollo Discovery loop devices. When this mode is active, the local LEDs on the loop device will flash when they are polled.

Limitations

In order to prevent current overload, the number of sounder control modules must be limited to 20 modules.

Loop devices in alarm will have their local LEDs activated. To limit the amount of current on the loop, the maximum number of local LEDs that may be active at any one time is 10.

Inhibit

Using the point display within S³, each Apollo device can be inhibited individually. Furthermore, using the “Global Inhibit” function within S³’s device display will inhibit the ASM Module, causing all devices on an ASM loop to be inhibited.

MAINTENANCE

To ensure reliable protection, it is important to check the ASM Module on a regularly scheduled basis. The frequency of checks is determined by the requirements of the particular installation. Reference EQP Safety Manual (95-8599) for additional ASM maintenance, including proof test intervals.

REPLACEMENT PARTS

The ASM Module is not designed to be repaired in the field. If a problem should develop, first carefully check for proper wiring and programming. If it is determined that the problem is caused by an electronic defect, the device must be returned to the factory for repair.

NOTE

When replacing a device, be sure that all rocker switches on the replacement are set the same as the original device. Consult the settings documented during system installation and setup to determine proper settings for the new device. Remove power before removing a device or plugging in a replacement unit. When a device is replaced with an identical device set to the same address, configuration is done automatically.

DEVICE REPAIR AND RETURN

Prior to returning devices, contact the nearest local Detector Electronics office so that the Return Material Identification (RMI) number can be assigned.

A written statement describing the malfunction must accompany the returned device or component to assist and expedite finding the root cause of the failure.

Pack the unit properly. Always use sufficient packaging material. Where applicable, use an antistatic bag as protection from electrostatic discharge.

NOTE

Det-Tronics reserves the right to apply a service charge for repairing returned product damaged as a result of improper packaging.

Return all equipment via transportation prepaid to the factory in Minneapolis.

ORDERING INFORMATION

When ordering, please specify:

EQ3760ASM Addressable Smoke Module

Refer to the ASM Module Model Matrix for details.

MODEL	DESCRIPTION
EQ3760	Addressable Smoke Module (ASM)
TYPE	MOUNTING OPTION
D	Din Rail
P	Panel Mount
TYPE	APPROVAL AGENCY
T	FM/CSA/ATEX/CE/IECEX/SIL2

For additional information or for assistance in designing a system to meet the needs of a specific application, please contact:

Detector Electronics Corporation
6901 West 110th Street
Minneapolis, Minnesota 55438 USA
Operator: (952) 941-5665 or (800) 765-FIRE
Customer Service: (952) 946-6491
Fax: (952) 829-8750
Web site: www.det-tronics.com
E-mail: det-tronics@det-tronics.com

For information on ordering ASM Module loop field devices, contact Detector Electronics.

APPENDIX A

IS WIRING DIAGRAM SCHEMATIC

In safe area (standard) applications it will be normal practice to connect the wiring as a loop, with both ends terminated at the control panel. In the event of an open-circuit fault it is possible to drive both ends simultaneously. In a hazardous area it is not possible to use a loop configuration because the potential to feed power from each end of the loop would double the available energy in a hazardous area and contravene the energy limitations of the I.S. Certification. All XP95 I.S. circuits must therefore be connected as spurs from the safe area loop or as radial connections from the control panel.

It is recommended, for the highest system integrity, that each I.S. circuit be restricted to a single zone and that the connection from the safe area loop to the I.S. spur be protected on each by XP95 isolators. The DIN-rail dual isolator is particularly suited to this application.

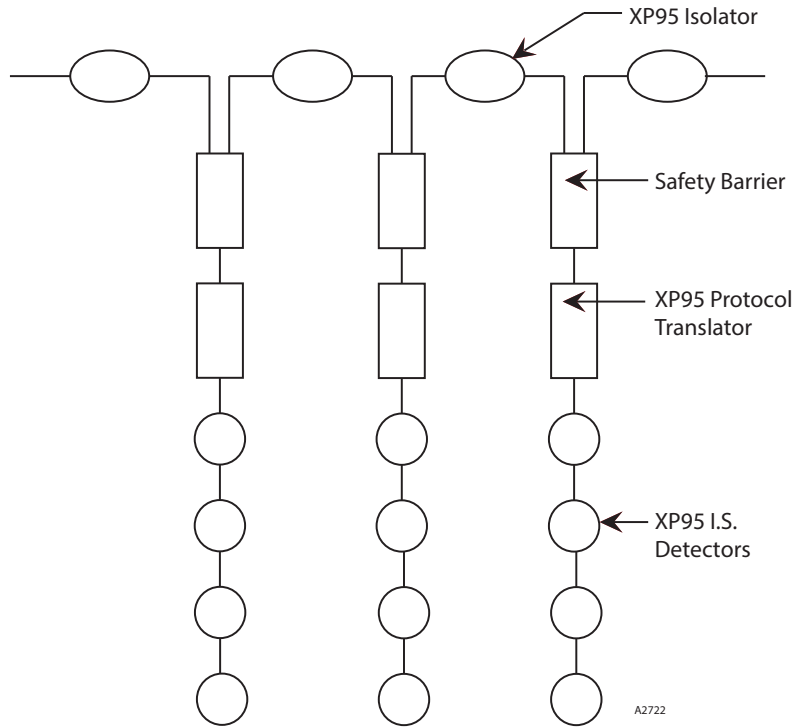

















Figure 9—XP95 Wiring Schematic

Equipment Safety Symbols

Symbol	Description
	Direct current
	Alternating current
	Both direct and alternating current
3 	Three-phase alternating current
	Earth (ground) current
	Protective conductor terminal
	Frame or chassis terminal
	On (power)
	Off (power)
	Equipment protected throughout by double insulation or reinforced insulation
	Caution, possibility of electric shock
	Caution, hot surface
	Caution*
	In position of bi-stable push control
	Out position of bi-stable push control
	Ionizing radiation

* Manufacturer to state that documentation must be consulted in all cases where this symbol is marked.



95-8755



FlexSonic™ Acoustic
Leak Detector



X3301 Multispectrum
IR Flame Detector



PointWatch Eclipse® IR
Combustible Gas Detector



FlexVu® Universal Display
with GT3000 Toxic Gas Detector



Eagle Quantum Premier®
Safety System

Specifications subject to change without notice.

All trademarks are the property of their respective owners.
© 2021 Carrier. All Rights Reserved.

Det-Tronics manufacturing system is certified to ISO 9001—
the world's most recognized quality management standard.



Corporate Office
6901 West 110th Street
Minneapolis, MN 55438 USA
www.det-tronics.com

Phone: +1 952.941.5665
Toll-free: +1 800.765.3473
Fax: 952.829.8750
det-tronics@carrier.com